

About VEAB

Corporate presentation
Product overview



Duct heaters – electric

Chap. 1	Circular	CV
Chap. 2	Rectangular	VFL / VFLPG / VTL / VRA
Chap. 3	Rectangular – ATEX-approved	VFL2-Ex / VTL2-Ex / VRA2-Ex



Duct Heaters/Coolers – Water/DX-coil/Refrigerants

Chap. 4	Circular for Hot Water	CWW / CFW
Chap. 5	Rectangular for Hot Water	PGV
Chap. 6	Circular for Cooled Water	CWK / CFK
Chap. 7	Rectangular for Cooled Water	PGK
Chap. 8	Rectangular with DX Coil	PGDX
Chap. 9	Customised heaters/coolers/condensers	WHS / WCS / SHS / DXES / DXCS / CS



Fans Heaters – Electrical

Chap. 10	For demanding environments	ROBUST
Chap. 11	Wall-mounted	EA
Chap. 12	Wall-mounted	ENV-L
Chap. 13	Portable/Wall-mounted	BX
Chap. 14	Smaller portable	KX 2



Fan Air Heaters/Coolers – Water/Coolants

Chap. 15	For demanding environments	AW C / CE / D / Ex / H
Chap. 16	Fan Heaters for Corrosive Environments	AW DX22CE
Chap. 17	Cooling/Heating Fans	AW DX / K
Chap. 18	Permanently Wall Mounted	AW
Chap. 19	Permanently Ceiling Mounted	CAW



Dehumidifiers

Chap. 20	For Construction Industry/Hiring	LAF 51
	For Water Damage/Cellars	LAF 31
	For Domestic Use	LAF 13



Leading Solutions in Heating

VEAB Heat Tech AB is specialised in developing, manufacturing and marketing heating products for ventilation systems, mobile and stationary fan heaters and dehumidifier units. We are the leading European company in electric duct heaters. Our products and systems contribute in different ways to creating a comfortable indoor climate. Our extensive qualifications in the field and a recognised high quality make VEAB Heat Tech a strong brand.



VEAB is the leading European company in electric duct heaters. The company was founded in the middle of the 1960s and that explains our long-standing experience and extensive qualifications in the field. Over the years, we have developed a broad product programme focussed on creating a comfortable indoor climate.

Comprehensive Solutions for Optimal Results

VEAB's product programme includes a broad range of heating, cooling, or dehumidifying products. Most products are available with integrated regulating equipment ready for operation. This makes the job easier and guarantees proper operation. Many applications require special solutions and adjustments. Our design and development department has extensive experience and will help you find a solution that fits your needs.



Electric Duct Heaters

VEAB's circular and rectangular electric duct heaters are used to heat the ventilation air for various rooms and areas each with individually controlled temperatures. Plug-in mounting and integrated regulating equipment provide for quick and easy installation. These heaters are also available with an external control device.



Electric Fan Heaters

VEAB's electric fan heaters are available for permanent installation or mobile use. The series includes fans for humid, wet, and corrosive environments that are suitable for heating in industrial plants, on construction sites, vehicle washing facilities, stables, and garages. There are even fans that meet very stringent requirements in terms of electrical safety, which are suitable for use on ships and in the off-shore industry. VEAB's small, mobile fan heaters provide comfortable auxiliary heat in vacation homes, garages and similar premises.

Thermal Fluid Duct Heaters/Coolers

VEAB's circular and rectangular thermal fluid duct heaters/coolers are used to heat or cool the ventilation air in a ventilation system for various rooms and areas in a building.



Thermal Fluid Fan Heaters/Coolers

VEAB's thermal fluid fan heaters are used for permanent heating/cooling of warehouses, industrial premises, workshops, sports halls, shops and the like.



Dehumidifiers

VEAB's mobile dehumidifiers for professionals are used for drying/dehumidifying on construction sites, in warehouses, in the event of water damage and more.

We also offer a compact and efficient air-dehumidifier for private use in laundry rooms, cellars and small-sized rooms.





CV
Circular electric duct heaters

CV

Circular electric duct heaters

VEAB's circular electric duct heaters are used to heat the ventilation air for various rooms and areas with individually controlled temperatures. When the system is appropriately sized, they can even heat up the entire building.

Circular electric duct heaters are also used for pre-heating or post-heating in air handling units. The duct heaters are available with an integrated electronic regulator or for external feedback control. An electronic flow switch can also be integrated.

- 7 sizes Ø 100 - 400 mm
- Output range 200 W – 15,000 W
- Air tightness class C as per EN 15727
- Integrated electronic flow switch is included in several models
- Integrated regulator or external feedback control
- Two integrated overheating protection devices
- Enclosed stainless tubular heating elements

Standard Design

The casing is made of aluzinc-coated sheet steel and the heating elements of stainless steel, EN 1.4301. The junction box contains all the terminals required for electrical connection.

The duct connection is suitable for push-in assembly in round ducts. CV duct heaters are manufactured with an IP44 degree of protection, but are also available with IP55 (except -MQU, -MTU, and -PTU).

Overheating Protection

All models in the CV series come with two overheating protection devices, one with an automatic reset and the other with a manual reset. These are connected in series with the heating elements upon delivery and therefore do not need to be connected to any external relay (except model -E, see p. 13). This provides increased security and lower installation costs. All duct heaters feature a reset button for the overheating protection on the heater cover.

Air Velocity

The duct heaters are manufactured for a minimum air velocity of 1.5 m/s. However, some models are suitable for air velocities down to 0.5 m/s, see pp. 14-15.

Air Tightness Class C

CV duct heaters meet air tightness class C, which ensures that the heated air reaches its destination and does not leak out of the ventilation system—that saves both energy and money.



Electronic Flow Switch

All models with an integrated control unit and for air velocities down to 1.5 m/s, there also is an option for adding an integrated electronic flow switch.

The flow switch continuously monitors the airflow and switches off the heater if the air velocity drops below 1.5 m/s and thus prevents overheating. When the air velocity rises above 1.5 m/s again, the heater is automatically switched back on. This implies that CV duct heaters with an integrated flow switch meet the requirement for interlocking with the fan/air flow and can be installed without any external interlock. This results in a very simple installation.

Alarm Relay, Addition -L

All models can be equipped with an integrated relay with potential-free alarm contact, which indicates loss of voltage or whether the manually resettable overheating protection device has tripped. The alarm relay is included as standard in models -MQXL, -MTXL, and -PTXL.

Approvals

Our duct heaters are tested and approved by Intertek Semko AB in accordance with the following directives:

LVD directive: EN 60355-1 and EN 60355-2-30

EMC directives: EN 61000-6-3 and EN 61000-6-1

EMF directive: EN 62233



Control Unit

Integrated Regulator

The integrated regulator provides for a simple installation, among others, because it requires less cabling, which reduces both the installation cost and the risk of misconnections.

The regulator is electronic and regulates the output using a triac with so-called time-proportional control (pulse/pause technology). This results in very accurate temperature control. Since feedback control is performed electronically, its operation is completely noiseless and involves minimal wear. The following models are available with an integrated regulator:

-MQU(L) and -MTU(L), for One Sensor

Duct heaters with integrated temperature regulator, for room or duct sensors. The setpoint is adjusted on the duct heater's cover or externally. See page 6.

-MQEM(L) and -MTEM(L), for Two Sensors

Duct heaters with integrated temperature regulator for external room sensor with setpoint adjuster. The min./max. inlet air temperature is adjusted on the duct heater's circuit board.

See page 8.

-MQXL and -MTXL, for 0...10 V Control Signal

Duct heaters with integrated regulator for external 0...10 V control signal. See page 10.

-MQCL / -MTCL, for 4...20 mA Control Signal

Contact VEAB for further information.

Air Velocities Down to 0.5 m/s -PTU(L), -PTEM(L), -PTXL, -P(L)

See pages 14-15.

External Regulator

There also are duct heaters without integrated regulator that can instead be complemented with an external one. The following models are available for an external regulator:

-M(L) and -E(L)

The duct heater is complemented with an external temperature regulator and sensor. See pages 12 and 13.

Additional Options

There are several options beyond the standard design that can be adapted to your application.

Other Types of Materials

The casing can be made of stainless steel, EN 1.4301, or of acid-resistant stainless steel, EN 1.4404.

Anti-condensation Insulation (except CV Ø100, Ø250, Ø315 and Ø400)

To reduce the risk of condensation in the junction box when the duct heater is installed in a warm and humid area, at the same time as the air in the duct is cold, a 4 mm thick insulation is added to the inside of the junction box.

IP55 Degree of Protection

Our duct heaters can be manufactured with an IP55 degree of protection instead of the standard IP44.

Modbus

The duct heaters may be equipped with Modbus communication. Contact VEAB for further information.

Duct Heaters with Outlet Temperatures Higher Than 50 °C

Only available in a rectangular design with circular connections. See "Rectangular Electric Duct Heaters".

Dimensions Above 400 mm in Diameter

Only available in a rectangular design with circular connections. See "Rectangular Electric Duct Heaters".

Output Above 15 kW

Only available in a rectangular design with circular connections. See "Rectangular Electric Duct Heaters".

Reinforced Electrical Insulation

To avoid leakage currents to earth, the heating elements are mounted in electrically insulating material. Suitable for marine use, for example.

Product Range Overview

Size designation		CV 10	CV 12	CV 16	CV 20	CV 25	CV 31	CV 40
Diameter (Ø mm)		100	125	160*	200	250	315	400 **
Minimum air volume m ³ /h		43	70	110	170	270	415	690
Output	Voltage							
300 W	230 VAC 1-ph.		X ³	X ²				
400 W	230 VAC 1-ph.	X ³						
600 W	230 VAC 1-ph.	X ³	X ⁵	X ³	X ²	X ¹		
900 W	230 VAC 1-ph.		X ⁷	X ⁴	X ²	X ²	X ¹	
1200 W	230 VAC 1-ph.		X ⁸	X ⁵	X ³	X ²	X ¹	
1500 W	230 VAC 1-ph.		X ⁹	X ⁶	X ³	X ³	X ²	
1800 W	230 VAC 1-ph.		X ¹⁰	X ⁶	X ⁴	X ³	X ²	
2100 W	230 VAC 1-ph.			X ⁷	X ⁴	X ³	X ²	
2700 W	230 VAC 1-ph.			X ⁸				
3000 W	230 VAC 1-ph.				X ⁶	X ⁴	X ³	X ²
3000 W	400 VAC 2-ph.				X ⁶	X ⁴	X ³	X ²
3300 W	400 VAC 2-ph.			X ⁹				
5000 W	400 VAC 2-ph.			X ¹²	X ⁸	X ⁶	X ⁴	X ³
6000 W	400 VAC 2-ph.				X ⁹	X ⁷	X ⁴	X ³
5000 W	400 VAC 3-ph.			X ¹²				
6000 W	400 VAC 3-ph.				X ⁹	X ⁷	X ⁴	X ³
9000 W	400 VAC 3-ph.					X ⁹	X ⁶	X ⁴
12000 W	400 VAC 3-ph.					X ¹⁰	X ⁷	X ⁵
15000 W	400 VAC 3-ph.							X ⁵

*= Also available with a 150 mm diameter.
 **= Also available with a 355 mm diameter.

- ¹= See pressure drop curve 1
- ²= See pressure drop curve 2
- ³= See pressure drop curve 3
- ⁴= See pressure drop curve 4
- ⁵= See pressure drop curve 5
- ⁶= See pressure drop curve 6
- ⁷= See pressure drop curve 7
- ⁸= See pressure drop curve 8
- ⁹= See pressure drop curve 9
- ¹⁰= See pressure drop curve 10
- ¹¹= See pressure drop curve 11
- ¹²= See pressure drop curve 12

Pressure Drop Chart

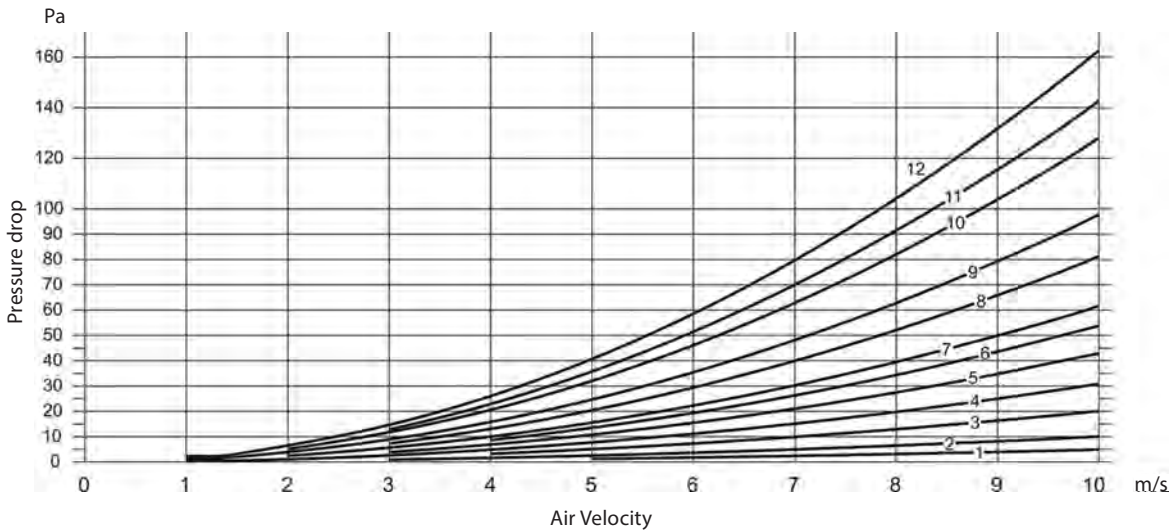

Installation

These duct heaters can be mounted in horizontal or vertical ducts. The air flow through the duct heater must follow the air direction arrow on the duct heater. In horizontal ducts, the junction box must be installed pointing up or rotated to the sides by up to 90°. Installation with the junction box pointing down is not allowed. The distance to or from a duct bend, fan, damper, etc. must be at least equal to twice the connection diameter.

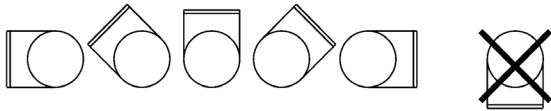

Interlocking with Fan/Air Flow

Electric duct heaters must always be installed in such a way that they are interlocked with the fan that blows air into the duct or with the air flow streaming through the heater. The power fed to the duct heater must be cut off, should the fan be shut off or if the air flow ceases.

Models -MQU, -MQEM and -MQXL with an integrated electronic flow switch meet the requirement for interlocking with the fan/air flow and can be installed without any external interlock.

For all other models, this function must be connected to the input voltage fed to the duct heater or directly connected to the integrated regulator, if any.

Minimum Air Velocity and Output Temperature

The duct heaters are dimensioned for a minimum air velocity of 1.5 m/s and an operating outlet air temperature of 50 °C max. (for higher temperatures, see “Rectangular Electric Duct Heaters”).

Ambient temperature during operation:
 Without integrated control device = 40 °C max.
 With integrated control device = 30 °C max.

The air velocity can be calculated using the following formula:

$$V = \frac{Q}{3600 \times A}$$

V = air velocity, m/s
 Q = air flow, m³/h
 A = sectional area of duct heater, m²

$$A = \frac{\pi \times D^2}{4}$$

D = duct heater diameter, Ø m

Power Requirements

The volume of air that goes through the duct heater is heated according to the following formula:

$$P = Q \times 0.36 \times \Delta t$$

P = output in W
 Q = air flow in m³/h
 Δt = temperature increase in °C

Dimensional Drawing

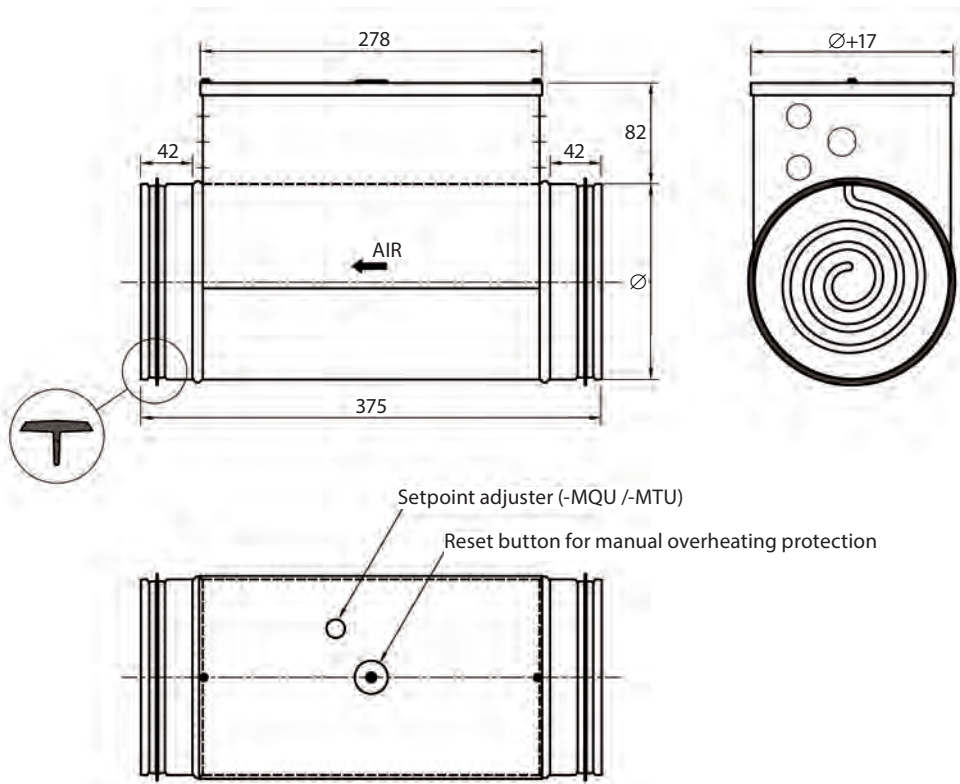

CV

Circular electric duct heater with built-in control equipment for a room or a duct sensor

The integrated controller provides for a simple installation among others due to less cabling. This in turn reduces both the installation cost and the risk of misconnections. The duct heater operates with an external room or duct sensor. The temperature is adjusted on the heater cover or on an external setpoint adjuster.

- MQU

Duct heater with integrated control device for room or duct sensors. The heater can be set up for external setpoint adjustment or for setpoint adjustment on the heater cover.

The -MQU model also has an integrated electronic flow switch that further simplifies installation as it can be installed as a “standalone” unit.

Sensors and a possible external setpoint adjuster are available as separate accessories.

- MTU

Same model as above, but without integrated electronic flow switch.

- MQUL and -MTUL

Same models as above, but with an additional integrated relay with potential-free alarm contact, which indicates loss of voltage or whether the manually resettable overheating protection device has tripped.



Project Design/Orders

Description – MQU

Duct heater, VEAB type CV -MQU, with casing made of aluzinc-coated sheet steel and heating elements made of stainless steel, EN 1.4301 The duct heater meets air tightness class C as per EN 15727. Integrated electronic flow switch. Feedback control is achieved by means of the integrated temperature regulator for room or duct sensors. Setpoint adjustment is performed externally or on the heater cover. Sensors and a possible setpoint adjuster must be ordered separately.

Type designation

(example)

Size designation, see page 4

Output in hundreds of watts

Voltage 1=230 VAC 1-ph. 2=400 VAC 2-ph. 3=400 VAC 3-ph.

Type of feedback control (-MQU/-MQUL/-MTU/ MTUL, see above)

Description – MTU

Duct heater, VEAB type CV -MTU, with casing made of aluzinc-coated sheet steel and heating elements made of stainless steel, EN 1.4301 The duct heater meets air tightness class C as per EN 15727. Feedback control is achieved by means of the integrated temperature regulator for room or duct sensors. Setpoint adjustment is performed externally or on the heater cover. Sensors and a possible setpoint adjuster must be ordered separately.

CV 16 - 50 - 2 MQUL

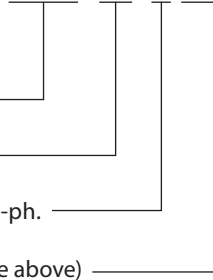

Accessories

There are several sensor/setpoint combinations for CV -MQU(L)/-MTU(L). Five typical cases are presented here. Data for sensors, see page 17. For a complete connection diagram, refer to the installation instructions on our website www.veab.com (select Products/Duct Heaters – Electric).

Duct Sensors

Option 1: Duct sensor with setpoint adjustment on heater cover.



TG-K330 as sensor.



The setpoint is adjusted manually on the duct heater cover.

Option 2: Duct sensor with separate setpoint adjustment.



TG-K330 as sensor.



TG-R430 as setpoint adjuster.

Room Sensors

Option 3: Room sensor with setpoint adjustment.



TG-R430 as setpoint adjuster and room sensor.

Option 4: Room sensor with separate setpoint adjustment.



TG-R530 (IP30) or TG-R630 (IP54) as room sensor.



TG-R430 as setpoint adjuster.

Option 5: Room sensor with setpoint adjustment on heater cover.



TG-R530 (IP30) or TG-R630 (IP54) as room sensor.



The setpoint is adjusted manually on the duct heater cover.

CV

Circular electric duct heater with built-in control equipment for two sensors – one room sensor and one min/max supply air sensor

The integrated controller provides for a simple installation among others due to less cabling. This in turn reduces both the installation cost and the risk of misconnections. The duct heater operates with an external room or duct sensor. The temperature is adjusted on an external setpoint adjuster.

- MQEM

Duct heaters with integrated control equipment for room sensors with TG-R430 setpoint adjusters and TG-K360 inlet air sensors. The desired room temperature is adjusted on the TG-R430. The min. and max. inlet air temperature is adjusted on the duct heater's circuit board.

The -MQEM model also has an integrated electronic flow switch that further simplifies installation as it can be installed as a "standalone" unit.

Sensors and setpoint adjusters are available as separate accessories.

- MTEM

Same model as above, but without integrated electronic flow switch.

- MQEML and -MTEML

Same models as above, but with an additional integrated relay with potential-free alarm contact, which indicates loss of voltage or whether the manually resettable overheating protection device has tripped.



Project Design/Orders

Description – MQEM

Duct heater, VEAB type CV -MQEM, with casing made of aluzinc-coated sheet steel and heating elements made of stainless steel, EN 1.4301 The duct heater meets air tightness class C as per EN 15727. Integrated electronic flow switch. Feedback control is achieved by means of an integrated temperature regulator for room sensors with setpoint adjusters and a separate inlet air sensor. Sensors and a external setpoint adjusters must be ordered separately.

Type designation

(example)

Size designation, see page 4

Output in hundreds of watts

Voltage 1=230 VAC 1-ph. 2=400 VAC 2-ph. 3=400 VAC 3-ph.

Type of feedback control (-MQEM/-MQEML/-MTEM/ MTEML, see above)

Description – MTEM

Duct heater, VEAB type CV -MTEM, with casing made of aluzinc-coated sheet steel and heating elements made of stainless steel, EN 1.4301 The duct heater meets air tightness class C as per EN 15727. Feedback control is achieved by means of an integrated temperature regulator for room sensors with setpoint adjusters and a separate inlet air sensor. Sensors and a external setpoint adjusters must be ordered separately.

CV 16 - 50 - 2 MQEML

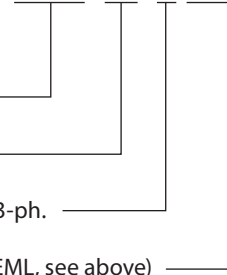

Accessories

There are several sensor/setpoint combinations for CV -MQEM(L)/-MTEM(L). Three typical cases are presented here. Data for sensors, see page 17. For a complete connection diagram, refer to the installation instructions on our website www.veab.com (select Products/Duct Heaters – Electric).

Room Sensors

Option 1: Room sensor with setpoint adjustment.



TG-R430 as setpoint adjuster and room sensor.



TG-K360 as min./max. inlet air sensor.

Option 2: Room sensor with separate setpoint adjustment.



TG-R530 (IP30) or TG-R630 (IP54) as room sensor.



TG-R430 as setpoint adjuster.



TG-K360 for min./max. inlet air temperature.

Duct Sensors

Option 3: Duct sensor with separate setpoint adjustment.



TG-K330 as outlet air sensor.



TG-R430 as setpoint adjuster.



TG-K360 as min./max. inlet air sensor.

CV

Circular electric duct heater with built-in control equipment for external 0...10V control signal

The integrated controller provides for a simple installation among others due to less cabling. This in turn reduces both the installation cost and the risk of misconnections.

- MQXL

Duct heaters with integrated control equipment for external 0...10 V control signal.

The -MQXL model also has an integrated electronic flow switch that further simplifies installation as it can be installed as a “standalone” unit.

The heater comes with an integrated relay with potential-free alarm contact, which indicates loss of voltage or whether the manually resettable overheating protection device has tripped.

- MTXL

Same model as above, but without integrated electronic flow switch.



Project Design/Orders

Description – MQXL

Duct heater, VEAB type CV -MQXL, with casing made of aluzinc-coated sheet steel and heating elements made of stainless steel, EN 1.4301 The duct heater meets air tightness class C as per EN 15727. Integrated electronic flow switch with potential-free alarm contact, which indicates loss of voltage or whether the manually resettable overheating protection device has tripped. Feedback control is achieved by means of an integrated regulator for external 0...10 V control signal.

Type designation

(example)

Size designation, see page 4

Output in hundreds of watts

Voltage 1=230 VAC 1-ph. 2=400 VAC 2-ph. 3=400 VAC 3-ph.

Type of feedback control (-MQXL/-MTXL, see above)

Description – MTXL

Duct heater, VEAB type CV -MTXL, with casing made of aluzinc-coated sheet steel and heating elements made of stainless steel, EN 1.4301 The duct heater meets air tightness class C as per EN 15727. Integrated relay with potential-free alarm contact, which indicates loss of voltage or whether the manually resettable overheating protection device has tripped. Feedback control is achieved by means of an integrated regulator for external 0...10 V control signal.

CV 16 - 50 - 2 MQXL

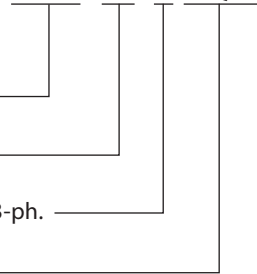

Feedback Control with Accessories

There are several ways to regulate a CV -MQXL/-MTXL. Three examples are presented here. For a complete connection diagram, refer to the installation instructions on our website www.veab.com (select Products/Duct Heaters – Electric).

Higher Level Systems



0-10 V



Air Handling Unit Having an Integrated Control Unit with a 0...10 V Output for Post-heating Battery



0-10 V



0...10 V Regulator Control



0-10 V



CV

Circular electric duct heater for external control equipment

VEAB electric duct heaters for external control are complemented with an external temperature regulator. They can be installed on walls or in control cabinets. Regulators and sensors must be ordered separately, see pages 16 and 17.

- M

A PULSER or TTC regulator is most suitable for its feedback control.

The overheating protection is reset manually on the duct heater cover. Output up to 9000 W.

- ML

Same model as above, but with an additional integrated relay with potential-free alarm contact, which indicates loss of voltage or whether the manually resettable overheating protection device has tripped.



Project Design/Orders

Description – M

Duct heater, VEAB type CV -M, with casing made of aluzinc-coated sheet steel and heating elements made of stainless steel, EN 1.4301 The duct heater meets air tightness class C as per EN 15727. Feedback control is achieved by means of an external regulator to be ordered separately.

Description – ML

Duct heater, VEAB type CV -ML, with casing made of aluzinc-coated sheet steel and heating elements made of stainless steel, EN 1.4301 The duct heater meets air tightness class C as per EN 15727. Integrated relay with potential-free alarm contact, which indicates loss of voltage or whether the manually resettable overheating protection device has tripped. Feedback control is achieved by means of an external regulator to be ordered separately.

Type designation

(example)

Size designation, see page 4

Output in hundreds of watts

Voltage 1=230 VAC 1-ph. 2=400 VAC 2-ph. 3=400 VAC 3-ph.

Type of feedback control (-M/-ML, see above)

CV 16 - 50 - 2 ML

CV

Circular electric duct heater for external control equipment

VEAB electric duct heaters for external control are complemented with an external temperature regulator. They can be installed on walls or in control cabinets. Regulators and sensors must be ordered separately, see pages 16 and 17.

- E

A PULSER or TTC regulator is most suitable for its feedback control.

The integrated manual overheating protection device is reset on the duct heater cover. The overheating protection devices are single pole and must be connected to the external control circuit. Output 12,000 W.



Project Design/Orders

Descriptive text -E

Duct heater, VEAB type CV -E, with casing made of aluzinc-coated sheet steel and heating elements made of stainless steel, EN 1.4301 The duct heater meets air tightness class C as per EN 15727. Feedback control is achieved by means of an external regulator to be ordered separately.

Type designation

CV 16 - 50 - 2 E

(example)

Size designation, see page 4

Output in hundreds of watts

Voltage 1=230 VAC 1-ph. 2=400 VAC 2-ph. 3=400 VAC 3-ph.

Type of regulation

CV

Electric circular duct heater for air velocity down to 0,5 m/s

Models

- PTU

Duct heater with integrated control device for room or duct sensors. The heater can be set up for external setpoint adjustment or for setpoint adjustment on the heater cover. For suggestions on combinations of sensors and possible external setpoint adjusters, see page 7.

Sensors and setpoint adjusters are available as separate accessories, see page 17.

- PTEM

Duct heaters with integrated control equipment for room sensors with TG-R430 setpoint adjusters and TG-K360 inlet air sensors. The desired room temperature is adjusted on the TG-R430. The min. and max. inlet air temperature is adjusted on the duct heater's circuit board. For suggestions on combinations of sensors and possible external setpoint adjusters, see page 9.

Sensors and setpoint adjusters are available as separate accessories, see page 17.

- PTXL

Duct heaters with integrated control equipment for external 0...10 V control signal.

The heater comes with an integrated relay with potential-free alarm contact, which indicates loss of voltage or whether the manually resettable overheating protection device has tripped.

- P

The duct heater is complemented with an external temperature regulator and sensor. PULSER regulators are most suitable for its feedback control for an output greater than 230 W. Below 230 W, we recommend a model with integrated control unit. The overheating protection is reset manually on the duct heater cover.

Regulators, sensors and setpoint adjusters are available as separate accessories, see page 16-17.

- PTUL, -PTEML, -PL

Same models as -PTU/-PTEM/-P, but with an additional integrated relay with potential-free alarm contact, which indicates loss of voltage or whether the manually resettable overheating protection device has tripped.



Installation

These duct heaters can be mounted in horizontal or vertical ducts. The air flow through the duct heater must follow the air direction arrow on the duct heater.

In horizontal ducts, the junction box must be installed pointing up or rotated to the sides by up to 90°. Installation with the junction box pointing down is not allowed. The distance to or from a duct bend, fan, damper, etc. must be at least equal to twice the connection diameter.

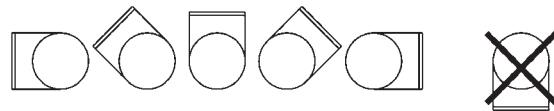

Interlocking with Fan/Air Flow

Electric duct heaters must always be installed in such a way that they are interlocked with the fan that blows air into the duct or with the air flow streaming through the heater. The power fed to the duct heater must be cut off, should the fan be shut off or if the air flow ceases.

Dimensional Drawing

See page 5.

Degree of Protection

CV-P... duct heaters are manufactured with an IP44 degree of protection, but are also available with IP55 (except model -PTU).

Minimum Air Velocity and Output

Temperature

The duct heaters are dimensioned for an air velocity down to 0.5 m/s and an operating outlet air temperature of 50 °C max. For a formula to calculate the air velocity, see page 5.

Power Requirements

For a formula to calculate the air velocity, see page 5.

Product Range Overview

Size designation		CV 08	CV 10	CV 12	CV 16
Diameter (∅ mm)		80	100	125	160*
Minimum air volume m ³ /h		9	15	24	37
Output	Voltage				
200 W	230 VAC 1-ph.	X ⁵	X ³	X ³	
400 W	230 VAC 1-ph.		X ³	X ⁵	
600 W	230 VAC 1-ph.			X ⁷	X ⁴
800 W	230 VAC 1-ph.			X ⁸	
1000 W	230 VAC 1-ph.			X ⁹	
1200 W	230 VAC 1-ph.			X ¹⁰	X ⁶
1800 W	230 VAC 1-ph.				X ⁸

*= Also available with a 150 mm diameter.

3= See pressure drop curve 3, on page 4

4= See pressure drop curve 4, on page 4

5= See pressure drop curve 5, on page 4

6= See pressure drop curve 6, on page 4

7= See pressure drop curve 7, on page 4

8= See pressure drop curve 8, on page 4

9= See pressure drop curve 9, on page 4

10= See pressure drop curve 10, on page 4

Project Design/Orders

Description – PTU

Duct heater, VEAB type CV -PTU, with casing made of aluzinc-coated sheet steel and heating elements made of stainless steel, EN 1.4301 The duct heater meets air tightness class C as per EN 15727 and is manufactured for air velocities down to 0.5 m/s. Feedback control is achieved by means of the integrated temperature regulator for room or duct sensors. Setpoint adjustment is performed externally or on the heater cover. Sensors and a possible setpoint adjuster must be ordered separately.

Description – PTXL

Duct heater, VEAB type CV -PTXL, with casing made of aluzinc-coated sheet steel and heating elements made of stainless steel, EN 1.4301 The duct heater meets air tightness class C as per EN 15727 and is manufactured for air velocities down to 0.5 m/s. Integrated relay with potential-free alarm contact, which indicates loss of voltage or whether the manually resettable overheating protection device has tripped. Feedback control is achieved by means of an integrated regulator for external 0...10 V control signal.

Description – PTEM

Duct heater, VEAB type CV -PTEM, with casing made of aluzinc-coated sheet steel and heating elements made of stainless steel, EN 1.4301 The duct heater meets air tightness class C as per EN 15727 and is manufactured for air velocities down to 0.5 m/s. Feedback control is achieved by means of an integrated temperature regulator for room sensors with setpoint adjusters and a separate inlet air sensor. Sensors and a external setpoint adjusters must be ordered separately.

Description – P

Duct heater, VEAB type CV -P, with casing made of aluzinc-coated sheet steel and heating elements made of stainless steel, EN 1.4301 The duct heater meets air tightness class C as per EN 15727 and is manufactured for air velocities down to 0.5 m/s. Feedback control is achieved by means of an external regulator to be ordered separately.

Regulators



PULSER



PULSER D



TTC 2000



TTC 40F

PULSER Series

A range of electric heating regulators that regulate the output using a so-called time-proportional control (pulse/pause technology). This results in very accurate temperature control.

IP30 degree of protection (PULSER D IP20).

Max. load 230 VAC 1-ph. 3200 W and 400 VAC 2-ph. 6400 W

PULSER

PULSER works with a sensor, the integrated room sensor or an external sensor, e.g. A duct sensor.

Automatic switch-over between 230 VAC 1-ph. and 400 VAC 2-ph.

PULSER D

Same properties as PULSER but for DIN mounting.

PULSER M

With extra input for min. or max. limiting sensors in the inlet air duct*. PULSER M will regulate the room temperature and at the same time keep a minimum inlet air temperature.

Automatic switch-over between 230 VAC 1-ph. and 400 VAC 2-ph.

*Use duct sensor/minimum sensor TG-K330.

PULSER ADD

PULSER ADD does not have any sensor of its own, but is instead controlled as a slave by another PULSER and works in parallel with it. This implies that you can control two duct heaters using the same sensor.

Automatic switch-over between 230 VAC 1-ph. and 400 VAC 2-ph.

TTC Series

A range of electric heating regulators that regulate the output using a so-called time-proportional control (pulse/pause technology). This results in very accurate temperature control. The setpoint is adjusted on the regulator or externally. The TTC series includes outputs for external main sensors and min./max. sensors

Use TG-K360 as min./max. sensor. As an alternative, the TTC series can be controlled by an external 0...10 V control signal.

TTC 2000

For wall mounting.

Maximum installed output: 17 kW, 400 VAC 3-ph.

Automatic switch-over: 210...415 VAC 3-ph.

Degree of protection: IP30

TTC 25 and TTC 40F

For mounting on DIN rail in a control cabinet.

Automatic switch-over: 210...415 VAC 3-ph.

Degree of protection: IP20

Maximum power outputs:

TTC 25: 25 A, 400 V, 17 kW

TTC 40F: 40 A, 400 V, 27 kW

PULSER 220 X010 and PULSER 380 X010

These regulators are controlled with an external 0...10 V control signal.

Voltage 230 VAC 1-ph. or 400 VAC 2-ph. respectively.

Accessories

	Product	Range	Degree of protection
	Duct sensor TG-K330	0-30 °C	IP20
	Duct sensor TG-K360 Min./max.sensor for TTC Series	0-60 °C	IP20
	Room sensor TG-R430 With setpoint adjustment	0-30 °C	IP30
	Room sensor TG-R530	0-30 °C	IP30
	Room sensor TG-R630	0-30 °C	IP54
	Pressure switch DTV300 incl. connection set	20 - 300 Pa 1 A max. 230 VAC 1-ph.	IP54
	Pressure switch AFS-222	10 - 3000 Pa 15A max. 230 VAC 1-ph.	IP20
	Connection set ANS	For AFS-222	



VEAB Heat Tech AB
Tel +46(0)451-485 00
www.veab.com • veab@veab.com
Sweden



VFL, VFLPG, VTL and VRA
Rectangular electric duct heaters



VFL, VFLPG, VTL and VRA

Rectangular electric duct heaters

VEAB's rectangular duct heaters are supplied in customised sizes and with an output of up to 2000 kW. They are used to heat up the inlet air in duct systems, in centralised air handling units and for various industrial processes. When they are properly dimensioned, rectangular duct heaters can handle heating an entire house or building.

Our flexible production enable us to precisely adapt the duct heaters to the intended application. This may concern heaters for air handling units, industrial processes or very harsh environments. This may require reinforced electrical insulation, stainless materials, large power requirements, high temperatures or the like.

- Output range 0.5 kW – 2000 kW
- Degree of protection IP43 as standard, IP55 or IP65 upon request
- Integrated control equipment or for external feedback control
- Integrated overheating protection devices, at least on with automatic reset and one with manual reset
- Enclosed stainless tubular heating elements
- 50/60 Hz
- Can be mounted horizontally or vertically

Standard Design

The casing is made of aluzinc-coated sheet steel, AZ 185, which meets the requirements for corrosion class C4. The heating elements are tubular heating elements made from stainless steel, EN 1.4301. The junction box contains all the terminals required for electrical connection. The casing is available in four different designs. See page 6 for further information. The duct heaters are manufactured with an IP43 degree of protection, but are also available with IP55 or IP65.

The products are customised in terms of size and output.

The heaters are suitable for a maximum outlet temperature of 50 °C, a minimum air velocity of 1.5 m/s and a maximum pressure of 1000 Pa.



Overheating Protection

All duct heater models come with at least two overheating protection devices, one with an automatic reset and the other with a manual reset. All duct heaters feature a reset button for the overheating protection on the heater cover.

Alarm Relay, Addition -L

All models can be equipped with an integrated relay with potential-free alarm contact, which indicates whether the manually resettable overheating protection device has tripped. An alarm relay is included as standard for models -MQXL, -MTXL, -MQYL, -MTYL, -MQCL, -MTCL, -MTUL, -MQUL, -MQEML and -MTEML.

Electronic Flow Switch

You can choose to add an electronic flow switch to any duct heater for 40 A 3-phase max. (e.g. 27 kW, 3x400 V max.). The flow switch continuously monitors the airflow and switches off the heater if the air velocity drops below 1.5 m/s and thus prevents overheating.

When the air velocity rises above 1.5 m/s the heater is turned on automatically if heating is required.

This implies that heaters with an integrated flow switch meet the requirement for interlocking with the fan/air flow and can be installed without any external interlock. This results in a very simple installation.

Approvals

Our duct heaters up to 1000 kW are tested and approved by Intertek Semko AB in accordance with the following directives:

LVD directive: EN 60335-1 and EN 60335-2-30

EMC directives: EN 61000-6-3 and EN 61000-6-1

EMF directive: EN 62233

Power ratings below 1000 kW are provided with S and CE markings.

Power ratings above 1000 kW are provided with a CE marking.



Control Unit Integrated Regulator

The integrated regulator provides for a simple installation, among others, because it requires less cabling, which reduces both the installation cost and the risk of misconnections. The regulator is electronic and regulates the output using a triac with so-called time-proportional control (pulse/pause technology). This results in very accurate temperature control. Since feedback control is performed electronically, its operation is completely noiseless and involves minimal wear. For higher outputs, parts of the output is regulated with a step controller. However, fine adjustment of the temperature is always performed by the electronic pulse/pause feedback control. Hinges in the cover facilitate maintenance and servicing. The following models are available with an integrated regulator:

-MTEML / -MQEML / -MTUL / -MQUL, for One or Two Sensors

Duct heaters with integrated temperature regulator, for room or duct sensors. Can also be connected to a main sensor in the room and to a min./max. sensor in the inlet air. See page 9.

-MQXL / -MTXL, for 0...10 V Control Signal

Duct heaters with integrated regulator for external 0...10 V control signal. See page 10.

-MQYL / -MTYL, for 2...10 V Control Signal

Contact VEAB for more information.

-MQCL / -MTCL, for 4...20 mA Control Signal

Contact VEAB for more information.

Modbus

The duct heaters may be equipped with Modbus communication

Contact VEAB for further information.

External Regulator

There also are duct heaters without integrated regulator that can instead be complemented with an external one. The following model is available for an external regulator:

-M(L)

The duct heater is complemented with an external temperature regulator or thermostat. See page 12.

Additional Options

There are several options beyond the standard design that can be adapted to your application.

Other Types of Materials

The casing can be made of stainless steel, EN 1.4301, or of acid-resistant stainless steel, EN 1.4404.

Duct Heaters for Outlet Temperatures Ranging from 51 °C to 120 °C

The overheating protection is adapted to the operating temperature.

The junction box is provided with 25 mm insulation against the duct part.

Duct Heaters for Outlet Temperatures Ranging from 121 °C to 400 °C

Acid-resistant or stainless casing. Overheating protection devices are adapted to the operating temperature. The junction box is provided with 100 mm insulation against the duct part. Air gap between duct and terminal box. IP30 degree of protection

Reinforced Electrical Insulation

To avoid leakage currents to earth, the heating elements are mounted in electrically insulating material. Suitable for marine use, for example.

Signal Lights

These are connected to the manual overheating protection and/or the operation indicator.

Hoisting Rings

The duct heaters can be provided with hoisting rings to facilitate installation.

IP55, IP65 Degree of Protection

Our duct heaters can be manufactured with an IP55 or IP65 degree of protection instead of the standard IP43.

Standstill Heater in the Terminal Box

A standstill heater may be useful for humid environments, for example, to reduce the risk of moisture entering through the heating element ends or to reduce the risk of condensation in the terminal box when cold air is flowing through the duct.

Circular Connection

If the output requirements or the connection diameter exceed what is available in the standard range for our circular duct heaters, CV, a rectangular duct heater is manufactured with circular connection.

Different Voltage

The heaters can be manufactured with a different voltage up to 3 × 690 V for external control unit and up to 3 × 500 V for integrated control unit.

Integrated Circuit Breaker

Only manufactured for models with integrated control equipment.

Pressure Above 1000 Pa

Contact VEAB.

Installation

These duct heaters can be mounted in horizontal or vertical ducts. The air flow through the duct heater must follow the air direction arrow on the duct heater cover. On a horizontal duct, the terminal box can be placed to the right or to the left, but not above or below. The duct heater must be installed in such a way that it receives an even air flow over the entire surface. We recommend that the distance to or from duct bends, fans, dampers, etc. is at least equal to the diagonal dimension of the duct heater, i.e. from corner to corner within the heater's duct part.

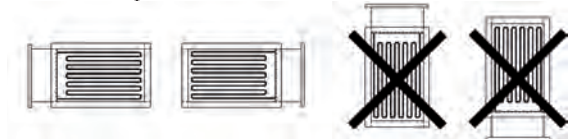

Interlocking with Fan/Air Flow

Electric duct heaters must always be installed in such a way that they are interlocked with the fan, which blows air into the duct, or with the air flow streaming through the heater. The duct heater power must be cut off, should the fan be shut off or if the airflow ceases. For outputs higher than 30 kW, we recommend letting the fan keep blowing for at least 3 minutes before it is stopped.

Models with an integrated electronic flow switch meet the requirement for interlocking with the fan/air flow and can be installed without any external interlock.

Models -MTEML, -MTUL and -MTXL with an output up to 27 kW 3×400 V include a port on the circuit board to connect a pressure or flow switch. For outputs greater than 27 kW, the heater must be interlocked via the inbound control circuit. Model -M must always be interlocked with the inbound power supply.

Minimum Air Velocity and Output Temperature

The duct heaters are dimensioned by default for a minimum air flow of 1.5 m/s and a maximum operating temperature of 50 °C for the outlet air.

Ambient temperature during operation:

Without integrated control device = 40 °C max.

With integrated control device = 30 °C max.

The air velocity can be calculated using the following formula:

$$V = \frac{Q}{3600 \times A}$$

V = air velocity, m/s
 Q = air flow, m³/h
 A = sectional area of duct heater (W×H), m²

Power Requirements

The volume of air that goes through the duct heater is heated according to the following formula:

$$P = Q \times 0.36 \times \Delta t$$

P = output in W
 Q = air flow in m³/h
 Δt = temperature increase in °C

Head Loss of Air Flowing through Duct Heater

The head loss of the air flowing through a duct heater depends on the air velocity and the number of rows of heating elements in the heater.

The approximate number of rows of heating elements can be calculated using the following formula:

$$X = \frac{P}{A \times 15}$$

X = number of rows of heating elements
 A = flow passage area of duct heater, $W \times H$ in m^2
 P = total output in kW

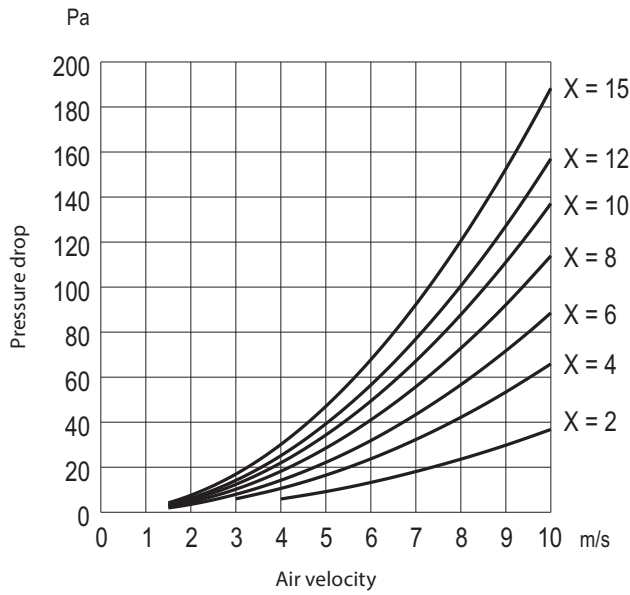

Surface Temperature of Heating Elements

The surface temperature of heating elements is dependent of the air velocity and the heating elements' surface effect.

The surface effect of the heating elements is approximately 3 W/cm^2 .

The table shows the surface temperature of the heating elements when the duct heater's outlet air temperature is about $20 \text{ }^\circ\text{C}$.

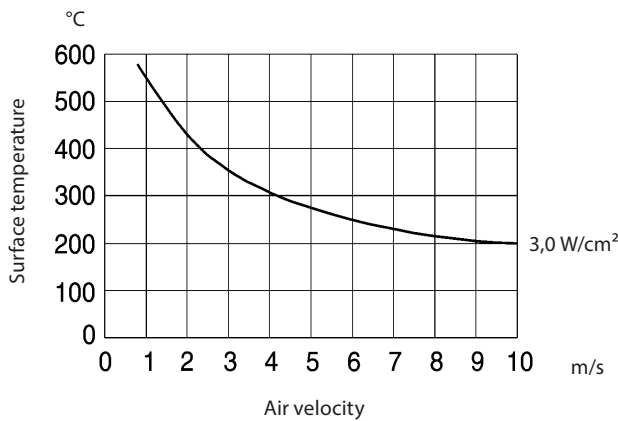

Dimensional Drawing

VFL – with Flanges

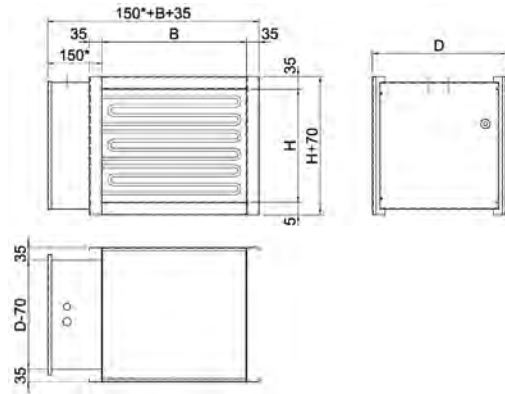

VFLPG – Suitable for PG Guide

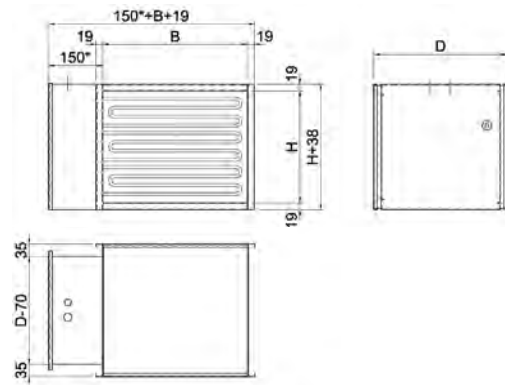

VTL – for Plug-in Mounting to Ducts

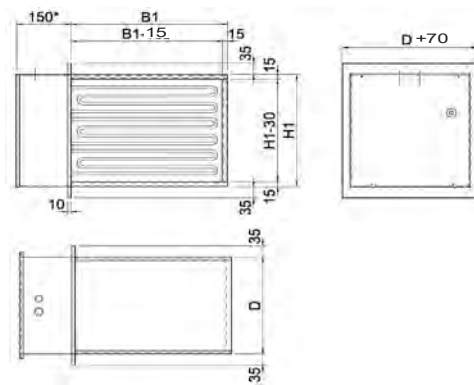

VRA – for Units

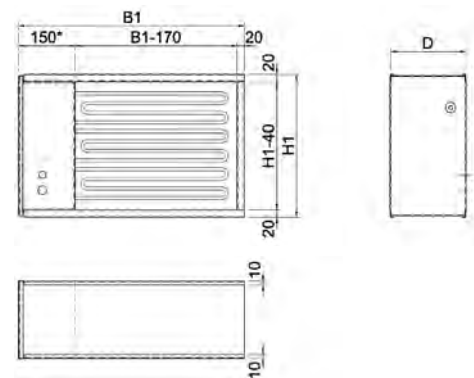

*) The dimension is 200 mm for duct heaters with integrated control equipment.

Project Design/Orders

Versions	VFL – with flanges VFLPG – suitable for PG guide VTL – for plug-in mounting to ducts VRA – for units	
Model	-MTEML / -MQEML / -MTUL / -MQUL -MQXL / -MTXL -MQYL / -MTYL -MQCL / -MTCL -M(L)	To be connected to a duct and/or room sensor. See page 9. Output is controlled by an external 0...10 V control signal. Output is controlled by an external 2...10 V control signal. Output is controlled by an external 4...20 mA control signal. For external control device.
Width dimension, W Height dimension, H	160 mm min. 3000 mm max. (open surface for air flow) 160 mm min. 3000 mm max. (open surface for air flow)	
Total output kW	Selectable between 0.5 kW and 2000 kW	
Main voltage	1 × 230 V = 1-phase 230 V 2 × 400 V = 2-phase 400 V 3 × 400 V = 3-phase 400 V 3 × 440 V = 3-phase 440 V	3 × 230 V = 3-phase 230 V 3 × 460 V = 3-phase 460 V 3 × 500 V = 3-phase 500 V 3 × 690 V = 3-phase 690 V
Casing material	A = Aluzinc, AZ 185 S = Stainless steel, EN 1.4301 SA = Acid-proof stainless steel, EN 1.4404	
Degree of protection	IP43 / IP55 / IP65	
Electric insulation	NI = Normal electrical insulation RI = Reinforced electrical insulation	
Outlet air temperature	50C = Outlet temperature 50 °C max. 120C = Outlet temperature 400 °C max.	

VFL / VFLPG / VTL / VRA

Type Designation VFL- and VFLPG-

The type designation of a duct heater can, for example, be VFLPG-M-1200-500-100-3×400V-SA-IP44-NI-50C and describes the product's execution. The type designation is structured as follows:

Design	Model	Width dimension, W	Height dimension, H	Total output kW	Main voltage V	Casing materials	Degree of protection	Electrical insulation	Outlet air temp.
VFLPG	M	1200	500	100 kW	3 × 400 V	SA	IP43	NI	50C

25 + 25 + 25 + 25

Number of stages and kW.
Only applies to model -M

Type Designation VRA- and VTL-

Design	Model	Width dimension, W1	Height dimension, H1	Total output kW	Main voltage V	Casing materials	Degree of protection	Electrical insulation	Outlet air temp.
VRA	M	1400	540	100 kW	3 × 400 V	SA	IP43	NI	50C

VFL, VFPLG, VTL and VRA

Rectangular electric duct heaters with built-in control equipment for one or two sensors

Duct heaters with integrated control equipment are supplied ready for installation.

This provides the following advantages:

- Minimum amount of cabling—fully connected control equipment
- Easy installation—reduced installation cost
- Minimum risk of misconnections during installation
- Accurate feedback control



- MTEML

To be connected to a duct or room sensor.

The setpoint is set externally, e.g. on the room sensor.

Can also be connected to two sensors, one main sensor in the room and one min./max. sensor in the inlet air.

Sensors are to be ordered separately. Includes a potential-free alarm contact, which indicates whether the manually resettable overheating protection device has tripped.

-MTEML is available with up to 635 ampere (440 kW, 3 x 400 V)

- MQEML

Same as MTEML plus an integrated electronic air flow switch that shuts off the heater at air velocities below 1.5 m/s.

-MQEML are available with up to 40 ampere (27 kW, 3 x 400 V)

- MTUL

To be connected to a sensor, e.g. A duct sensor in the inlet air.

The setpoint is set on the duct heater cover.

Includes a potential-free alarm contact, which indicates whether the manually resettable overheating protection device has tripped. Sensors are to be ordered separately.

- MTUL is available with up to 635 ampere (440 kW, 3 x 400 V)

- MQUL

Same as MTUL plus an integrated electronic air flow switch that shuts off the heat at air velocities below 1.5 m/s.

MQUL heaters are available with up to 40 ampere (27 kW, 3 x 400 V)

Project Design/Orders

Description – MQEML / MQUL

Duct heater, VEAB type VFPLG-MQEML-800-400-25 kW-3x400V-A-IP43-NI-50C (see page 7), with casing made of aluzinc-coated sheet steel, AZ 185, which meets the requirements for corrosion class C4. Heating elements made of stainless steel, EN 1.4301. Includes a potential-free alarm contact, which indicates whether the manually resettable overheating protection device has tripped. Includes an integrated electronic flow switch.

Feedback control is achieved by means of the integrated temperature regulator for room or duct sensors. Sensors and a possible external setpoint adjuster must be ordered separately.

Description – MTEML / MTUL

Duct heater, VEAB type VFPLG-MTEML-1200-500-100 kW-3x400V-A-IP43-NI-50C (see page 7), with casing made of aluzinc-coated sheet steel, AZ 185, which meets the requirements for corrosion class C4. Heating elements made of stainless steel, EN 1.4301. Includes a potential-free alarm contact, which indicates whether the manually resettable overheating protection device has tripped.

Feedback control is achieved by means of the integrated temperature regulator for room or duct sensors. Sensors and a possible external setpoint adjuster must be ordered separately.

Accessories

Sensors for MQUL and MTUL

The setpoint is set on the duct heater cover.

Opt. 1



TG-K330 as inlet air sensor.

Opt. 2



TG-R530 (IP30) or TG-R630 (IP54) as room sensor.

Sensors for MQEML and MTEML

The setpoint is set externally.

Opt. 1



TG-R430 as setpoint adjuster and room sensor.

Opt. 2



TG-R430 as setpoint adjuster and room sensor.

Opt. 3



TG-R530 (IP30) or TG-R630 (IP54) as room sensor.

Opt. 4



TG-R530 (IP30) or TG-R630 (IP54) as room sensor.



TG-R430 as setpoint adjuster.



TG-R430 as setpoint adjuster.

Opt. 5



TG-K330 as inlet air sensor.



TG-K360 as min./max. inlet air sensor.



TG-R430 as setpoint adjuster.

Data for all sensors, see page 15.
For a complete connection diagram, refer to the manual on our website www.veab.com (select Products/Duct Heaters – Electric).

VFL, VFLPG, VTL and VRA

Rectangular electric duct heaters with built-in control equipment for 0...10V external control signal

Duct heaters with integrated control equipment are supplied ready for installation. This provides the following advantages:

- Minimum amount of cabling—fully connected control equipment
- Easy installation—reduced installation cost
- Minimum risk of misconnections during installation
- Accurate feedback control

- MQXL

To be connected to an external 0...10 V control signal. Includes a potential-free alarm contact, which indicates whether the manually resettable overheating protection device has tripped. The heater includes an integrated electronic flow switch (see page 2).
-MQXL are available with up to 40 A 3-phase (27 kW 3×400 V).

- MTXL

To be connected to an external 0...10 V control signal. Includes a potential-free alarm contact, which indicates whether the manually resettable overheating protection device has tripped.
-MTXL are available with up to 440 kW.



Project Design/Orders

Description – MQXL

Duct heater, VEAB type VFLPG-MQXL-800-400-25kW-3x400V-A-IP43-NI-50C (see page 7), with casing made of aluzinc-coated sheet steel, AZ 185, which meets the requirements for corrosion class C4. Heating elements made of stainless steel, EN 1.4301. Includes a potential-free alarm contact, which indicates whether the manually resettable overheating protection device has tripped. Includes an integrated electronic flow switch. Feedback control is achieved by means of an integrated regulator for external 0...10 V control signal.

Description – MTXL

Duct heater, VEAB type VFLPG-MTXL-1200-500-100kW-3x400V-A-IP43-NI-50C (see page 7), with casing made of aluzinc-coated sheet steel, AZ 185, which meets the requirements for corrosion class C4. Heating elements made of stainless steel, EN 1.4301. Includes a potential-free alarm contact, which indicates whether the manually resettable overheating protection device has tripped. Feedback control is achieved by means of an integrated regulator for external 0...10 V control signal.

Wiring Example

- MQXL

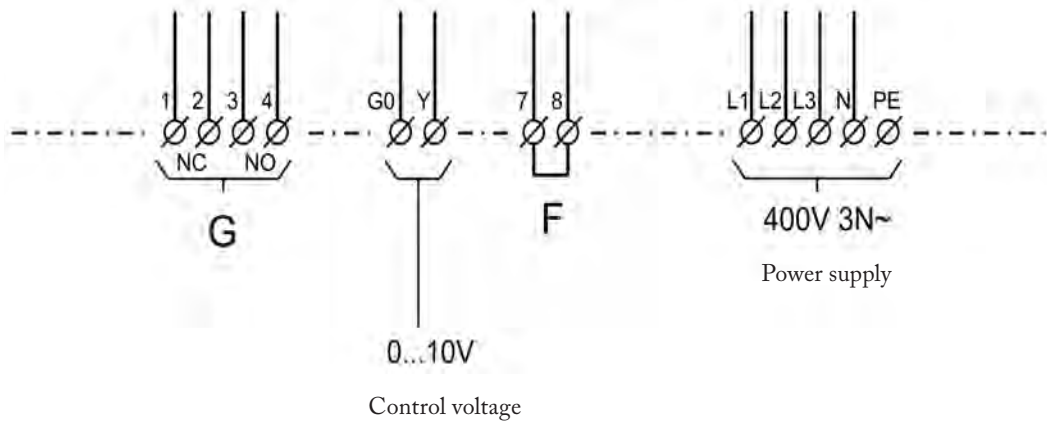

- F = Jumper can be replaced with control switch or other interlocking device (option)
- G = Alarm contacts for indication of tripped overheating protection
- NO = Normally open contact (closes in the event of overheating alarm)
- NC = Normally closed contact (opens in the event of overheating alarm).

Wiring Example

- MTXL

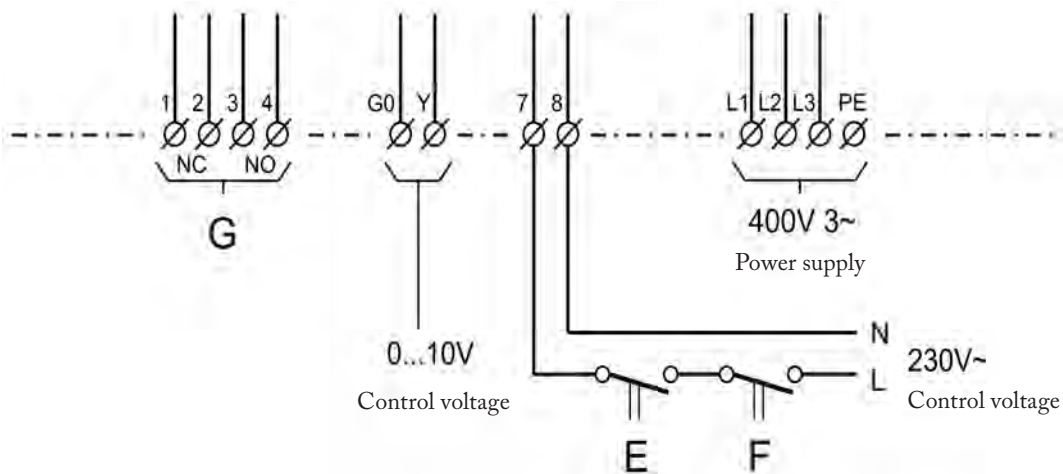

- E = Interlock
- F = Control switch
- G = Alarm contacts for indication of tripped overheating protection
- NO = Normally open contact (closes in the event of overheating alarm)
- NC = Normally closed contact (opens in the event of overheating alarm).

VFL, VFLPG, VTL and VRA

Rectangular electric duct heaters for external control equipment

The duct heaters are complemented with external control equipment. It is essential that the equipment is suitable for the heater and the output to be controlled. The table on p. 13 provides guidance on suitable control equipment.

- M

A PULSER or TTC regulator is most suitable for its external feedback control.

Choice of Output

The total output for duct heaters for external control equipment can be freely selected from 0.5 kW and up. The output can be broken down into any desired number of output stages with a minimum of 0.3 kW and a maximum of 43 kW per output stage (63 A).

Connecting Stages

Standard

Main voltage 400 VAC 3-ph.

0.3-3.5 kW: 400 VAC 2-ph.

3.6-43.0 kW: 400 VAC 3-ph.

Main voltage 230 VAC 3-ph.

0.3-1.99 kW: 230 VAC 1-ph.

2.0-25.0 kW: 230 VAC 3-ph.

Upon Request

0.3-3.6 kW: 230 VAC 1-ph.

0.3-6.0 kW: 400 VAC 2-ph.

1.0-43.0 kW: 400 VAC 3-ph. or 230 VAC 3-ph.



Project Design/Orders

Description – M

Duct heater, VEAB type VFLPG-M-1200-500-100kW-3x400V-A-IP43-NI-50C (see page 7), with casing made of aluzinc-coated sheet steel, AZ 185, which meets the requirements for corrosion class C4. Heating elements made of stainless steel, EN 1.4301.

Total output 100 kW.

Output stages 25 kW + 25 kW + 25 kW + 25 kW.

Feedback control is achieved by means of an external regulator to be ordered separately.

Wiring Example

6 kW max. 400 VAC 2-ph.

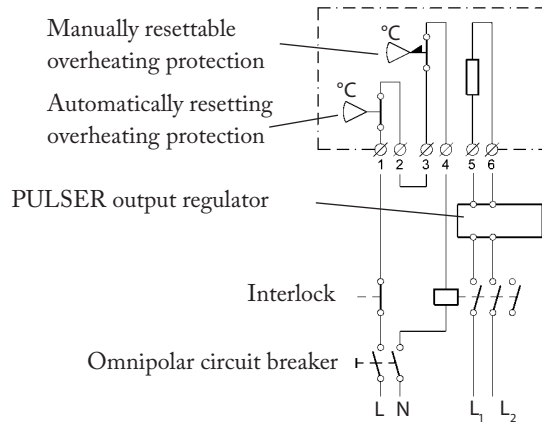

Wiring Example

81 kW max. 400 VAC 3-ph.

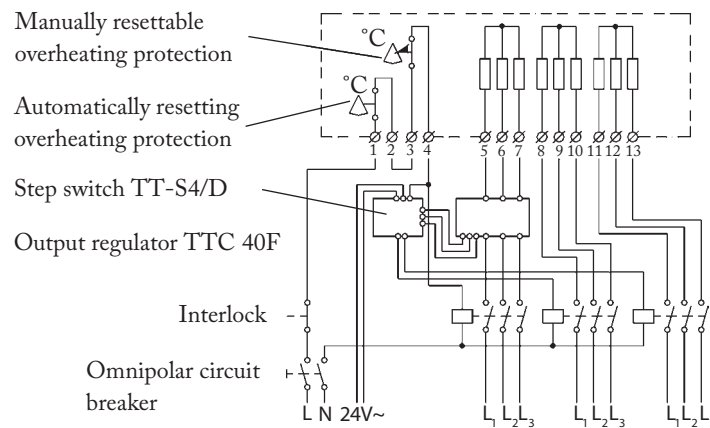

Choice of Regulator

Total output	Output stage	Regulators
0.5-6.0 kW	1 stage, 400 VAC 2-ph.	PULSER
6.1-17.0 kW	1 stage, 400 VAC 3-ph.	TTC 25 or TTC 2000
17.1-27.0 kW	1 stage, 400 VAC 3-ph.	TTC 40 F
17.1-34.0 kW	2 stages (1/2 + 1/2), 400 VAC 3-ph.	TTC 2000 + TT-S1
28.0-54.0 kW	2 stages (1/2 + 1/2), 400 VAC 3-ph.	TTC 40 F + TT-S4/D
55.0-81.0 kW	3 stages (1/3 + 1/3 + 1/3), 400 VAC 3-ph.	TTC 40 F + TT-S4/D
82.0-108.0 kW	4 stages (1/4 + 1/4 + 1/4 + 1/4), 400 VAC 3-ph.	TTC 40 F + TT-S4/D
109.0-135.0 kW	5 stages (1/5 + 1/5 + 1/5 + 1/5 + 1/5), 400 VAC 3-ph.	TTC 40 F + TT-S4/D
136.0-215.0 kW	Output ratio (1 + 1 + 2 + 4, 400 VAC 3-ph.)	TTC 40 F + TT-S4/D

Regulators



PULSER



PULSER D



TTC 2000



TTC 40F



Step switch
TT-S4/D

PULSER Series

A range of electric heating regulators that regulate the output using a so-called time-proportional control (pulse/pause technology). This results in very accurate temperature control.

IP30 degree of protection (PULSER D IP20).

Max. load 230 VAC 1-ph. 3200 W and 400 VAC 2-ph. 6400 W

PULSER

PULSER works with a sensor, the integrated room sensor or an external sensor, e.g. A duct sensor.

Automatic switch-over between 230 VAC 1-ph. and 400 VAC 2-ph.

PULSER D

Same properties as PULSER but for DIN mounting.

PULSER M

With extra input for min. or max. limiting sensors in the inlet air duct*. PULSER M will regulate the room temperature and at the same time keep a minimum inlet air temperature.

Automatic switch-over between 230 VAC 1-ph. and 400 VAC 2-ph.

*Use duct sensor/minimum sensor TG-K330.

PULSER ADD

PULSER ADD does not have any sensor of its own, but is instead controlled as a slave by another PULSER and works in parallel with it. This implies that you can control two duct heaters using the same sensor. Automatic switch-over between 230 VAC 1-ph. and 400 VAC 2-ph.

PULSER 220 X010 and PULSER 380 X010

These regulators are controlled with an external 0...10 V control signal.

Voltage 230 VAC 1-ph. or 400 VAC 2-ph. respectively.

TTC Series

A range of electric heating regulators that regulate the output using a so-called time-proportional control (pulse/pause technology). This results in very accurate temperature control. The setpoint is adjusted on the regulator or externally. The TTC series includes outputs for external main sensors and min./max. sensors

Use TG-K360 as min./max. sensor. As an alternative, the TTC series can be controlled by an external 0...10 V control signal.

TTC 2000

For wall mounting.

Maximum installed output: 17 kW, 400 VAC 3-ph.

Automatic switch-over: 210...415 VAC 3-ph.

Degree of protection: IP30

Circuit Board TT-S1

To be installed in TTC 2000 to control a fixed main stage of 17 kW max. At least 50% of the total output must be controlled via the TTC 2000 and 50% max. via TT-S1. Together, TTC 2000 and TT-S1 are capable of controlling up to 17 kW + 17 kW = 34 kW.

TTC 25, TTC 40F and TTC 63F

For mounting on DIN rail in a control cabinet.

Automatic switch-over: 210...415 VAC 3-ph.

Degree of protection: IP20

Maximum power outputs:

TTC 25: 25 A, 400 V, 17 kW

TTC 40F: 40 A, 400 V, 27 kW

TTC 63F: 63 A, 400 V, 43 kW

Step switch TT-S4/D

To be used together with TTC 25, TTC 40F or TTC 63F to regulate the parts of the total output that exceeds their capacity. Includes four relay outputs operating in sequential or binary mode.

Outputs: 4X2 A 240 VAC 1-ph. NO

Supply voltage: 24 VAC 1-ph.

Accessories

	Product	Range	Degree of protection
	Duct sensor TG-K330 for 220-400 V*	0-30 °C	IP20
	Duct sensor TG-K930 for 415-500 V*		
	Duct sensor TG-K360 Min./max.sensor for TTC series for 220-400 V*	0-60 °C	IP20
	Duct sensor TG-K960 Min./max.sensor for TTC series for 415-500V*		
	Room sensor TG-R430 With setpoint adjustment for 220-400 V*	0-30 °C	IP30
	Room sensor TG-R930 With setpoint adjustment for 415-500V*		
	Room sensor TG-R530 for 220-500 V*	0-30 °C	IP30
	Room sensor TG-R630 for 220-500 V*	0-30 °C	IP54
	Pressure switch DTV300 incl. connection set	20 - 300 Pa 1 A max. 230 VAC 1-ph.	IP54
	Pressure switch AFS-222	10 - 3000 Pa 15A max. 230 VAC 1-ph.	IP20
	Connection set ANS	For AFS-222	

* Refers to duct heater supply voltage



VEAB Heat Tech AB
Tel +46(0)451-485 00
www.veab.com • veab@veab.com
Sweden

VFL2-Ex, VTL2-Ex and VRA2-Ex
Rectangular electric duct heaters
for hazardous areas



VFL2-Ex, VTL2-Ex and VRA2-Ex

Rectangular electric duct heaters for hazardous areas

VEAB's rectangular ATEX-approved duct heaters are available for outputs up to 1000 kW and are used to heat air in duct systems, centralised air handling units and for various industrial processes in environments in which the risk of explosions is likely to occur occasionally (Zone 1 and Zone 2). Our flexible production enables us to adapt the duct heater to various areas of application such as offshore, chemical industry, oil industry and ships.

- Output range 1 kW - 1000 kW
- Temperature class T3 (200 °C max.)
- For use in areas in which the risk of explosions is due to gases or vapours (equipment category 2G)
- IP66 degree of protection
- Max. outlet temperature 40 °C
- Ambient temperature -50 °C to +40 °C
- Min. air velocity 2.5 m/s
- Can be mounted both horizontally and vertically
- Integrated overheating protection and temperature limiter
- VFL2-Ex has heating elements mounted in a removable magazine



Design

The casing can be made of stainless steel EN 1.4301 or from acid-resistant stainless steel EN 1.4404. The casing is available in three different designs, depending on the area of use. See page 6 for additional information. The duct heaters are manufactured with an IP65 degree of protection in accordance with EN 60529.

The heating elements are tubular heating elements made of stainless steel, EN 1.4301, or acid-resistant stainless steel, EN 1.4404, Incoloy 800 or Incoloy 825.

The surface effect is 1 W/cm² max. VFL2-Ex has heating elements mounted in a magazine. The magazine can be pulled out without the need for the duct section to be dismantled.

The terminal box is manufactured to comply with Ex eb (increased safety) requirements in accordance with EN 60079-7, and the integrated overheating protection devices and temperature limiter to comply with Ex db (explosion-proof enclosure)/ Ex mb (encapsulation) requirements in accordance with EN 60079-1.

The terminal box contains Ex eb-certified terminals for the electrical connection of the heating elements, the overheating protection devices and the temperature limiter.

The duct heater must be equipped with cable entries with IP66 protection or higher, approved for EX eb or EX db execution. These are not included in the supply.

Approvals

VEAB's approved duct heaters meet the requirements of the ATEX directive 2014/34/EU.

VEAB's quality system is certified by Intertek in accordance with certificate ITS12ATEXQ7607

Testing and certification are performed by Intertek in accordance with the following certificate: ITS10ATEX36956X

Testing standards applied:

IP66 degree of protection, EN 60529

General ATEX requirements EN 60079-0

Ex e (increased safety) EN 60079-7

The duct heaters are also tested and approved by Intertek in accordance with the following directives:

LVD directive: EN 60335-1 and EN 60335-2-30

EMC directives: EN 61000-6-3 and EN 61000-6-1

EMF directive: EN 62233

EAC certificate for Ex



Overheating Protection Devices/ Temperature Limiters

All duct heaters include two overheating protection devices for output stage 1, which limits the surface temperature of the heating elements to 200 °C (temperature class T3).

When there is a need for heating, the heating elements of output stage 1 must always be connected.

If the heater includes more than one output stage, output stage 1 must always be the one that is disconnected first whenever there is a need for heating.

Output stage number 1 must be the stage that is the last to be disconnected when the heater is switched off.

Furthermore, there is also an automatic temperature limiter, which limits the outlet temperature. Resetting the manual overheating protection devices is done inside the terminal box.

The overheating protection devices and the temperature limiter are designed with so-called intrinsic safety, i.e. a cut-off or leakage in the capillary system will cause the protection devices to permanently disconnect the safety circuits.

Anticondensation Heater in the Terminal Box

In order to further adapt the heater to your application you can choose to add an anticondensation heater in the terminal box. This is always recommended for damp environments and for outdoor installation in order to reduce the risk of insulation issues in the heating elements and to reduce the risk of condensation in the terminal box.

Please note that the anticondensation heater in the terminal box is an option that is not included as standard.

Dimensions

ATEX-approved duct heaters are manufactured according to the customers' requirements. Width and height are chosen in accordance with the duct or unit into which the heater is to be mounted. The dimensioning must account for the fact that the smallest air velocity flowing through the heater must be 2.5 m/s. The width (W) and height (H) dimensions must be at least 200 mm and may not exceed 3000 mm, the depth dimension must be at least 270 mm and will be specified by VEAB in the quote or in the order confirmation.

Markings

See page 5 for a description.

Control Unit

ATEX-approved duct heaters must be controlled by appropriate control equipment that has been approved for the specific environment in which the control equipment is placed. The control unit must also have a separate sensor that automatically limits the outlet air temperature from the heater battery to 40 °C. Follow local regulations applicable to control equipment for ATEX-certified duct heaters.

Voltage

The voltage can be adapted to the customer's requirements up to 690 VAC 3-ph.

Output Allocation

The total output can be allocated to any number of output stages with 63 A max. per stage.

If more than one output stage is used, we recommend all stages to be of the same size.

Circular Connection

A transition to a circular connection can be supplied as a separate accessory for VFL2-Ex. Diameter dimension 100-800 mm.

Pressure Above 1000 Pa

Contact VEAB.



II 2 G Ex db eb mb IIC T3 Gb

Installation

The duct heaters may be installed either horizontally or vertically. The air flowing through the heater must follow the air direction arrow on the duct heater cover. On a horizontal duct, the terminal box can be placed either to the right or to the left, but not downwards. The duct heater must be installed in such a way that it receives an even air flow over the entire surface. We recommend that the distance to or from duct bends, fans, dampers or such is at least equal to the diagonal dimension of the duct heater, i.e. from corner to corner within the heater's duct part. In other cases, air distribution plates must be fitted.

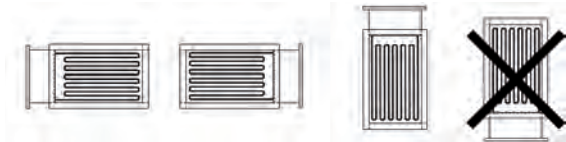

Duct Heaters with More than One Output Stage

For duct heaters with more than one output stage the integrated overheating protection devices are installed in output stage 1.

Output stage 1 must always be the first to be switched on when there is a need for heating and the last to be disconnected when the heater is switched off.

Interlocking with Fan/Air Flow

Electric duct heaters must always be installed in such a way that they are interlocked with the fan, which blows air into the duct, or with the air flow streaming through the heater. The duct heater power must be cut off, should the fan be shut off or if the airflow ceases. For outputs higher than 30 kW, we recommend letting the fan keep blowing for at least 3 minutes before it is stopped.

Minimum Air Velocity and Output Temperature

The duct heaters are dimensioned by default for a minimum air flow of 2.5 m/s and a maximum operating temperature of 40°C for the outlet air.

Ambient temperature during operation: -50...+40 °C.

The air velocity can be calculated using the following formula:

$$V = \frac{Q}{3600 \times A}$$

V = air velocity, m/s
 Q = air flow, m³/h
 A = sectional area of duct heater (W×H), m²

Power Requirements

The volume of air that goes through the duct heater is heated according to the following formula:

$$P = Q \times 0.36 \times \Delta t$$

P = output, W
 Q = air flow, m³/h
 Δt = temperature increase, °C

Head Loss of Air Flowing through Duct Heater

The head loss of the air flowing through a duct heater depends on the air velocity and the number of rows of heating elements in the heater. The approximate number of rows of heating elements can be calculated using the following formula:

$$X = \frac{P}{A \times 5}$$

X = number of rows of heating elements
 A = flow passage area of duct heater, W x H in m²
 P = total output in kW

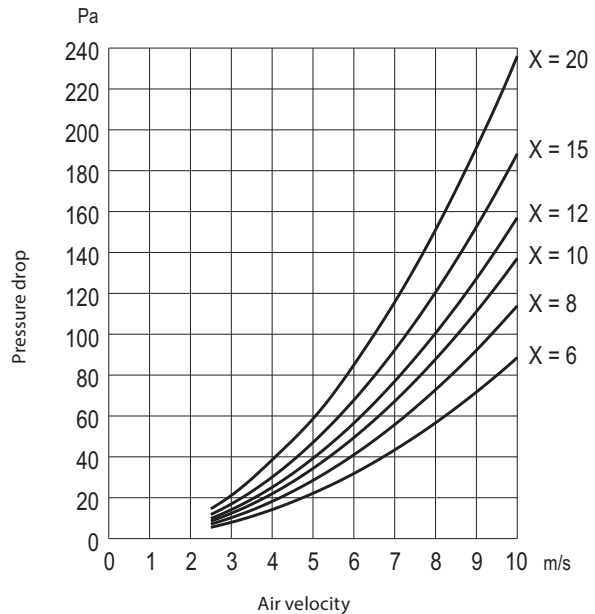



II 2 G Ex db eb mb IIC T3 Gb

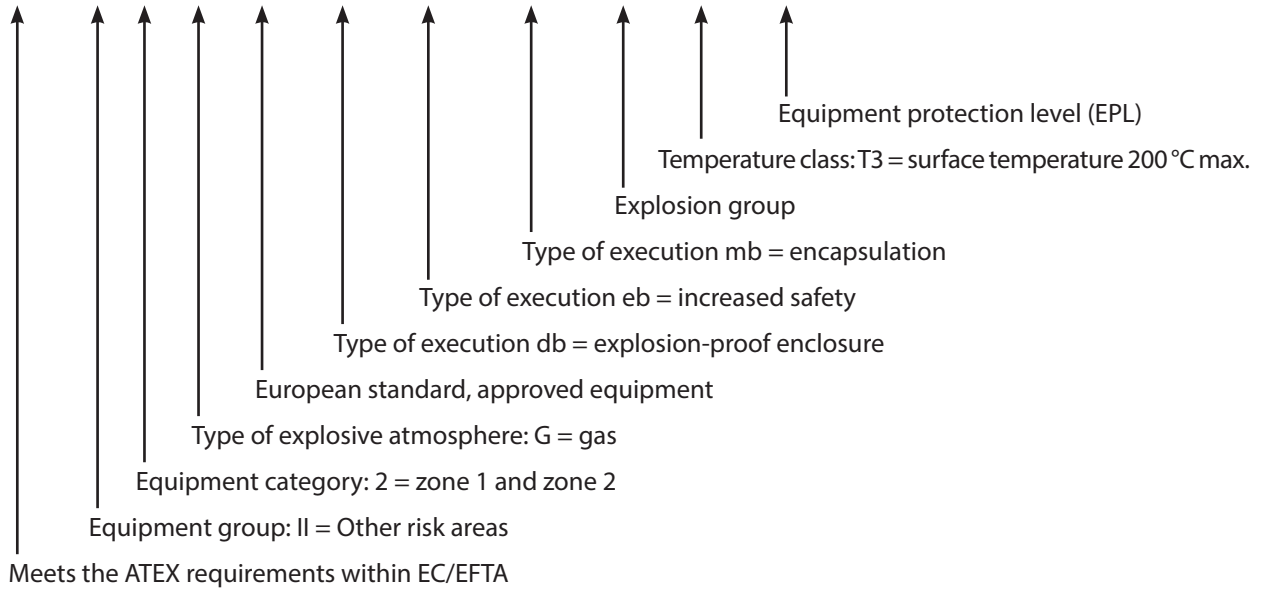

ATEX

Classification of risk area (Defines likelihood, duration and frequency of explosive gas mixture)		
Zone 2	Zone 1	Zone 0
Explosive gas mixture is not expected to occur during normal handling. If it does occur, it is rare and of short duration.	Explosive gas mixture is expected to occur during normal handling	Explosive gas mixture is expected to be continuously present or present for long periods.
Heaters can be used in		
3 G		
2 G (VEAB ATEX heater)		
1 G		

Explosion groups (Defines the spark energy required to ignite a gas mixture)		
IIA	IIB	IIC
Propane, acetone, benzene, petrol, diesel	Ethylene, town gas, ethylene glycol	Acetylene, hydrogen
Heaters can be used in		
IIA		
IIB		
IIC (VEAB ATEX heater)		

Temperature class (Defines the highest surface temperature on the equipment with respect to the ignition temperature of gas mixtures)					
T1	T2	T3	T4	T5	T6
≤450 °C	≤300 °C	≤200 °C	≤135 °C	≤100 °C	≤85 °C
Heaters can be used in					
T1					
T2					
T3 (VEAB ATEX heater)					
T4					
T5					
T6					

Dimensional Drawing

VFL2 – with Flanges

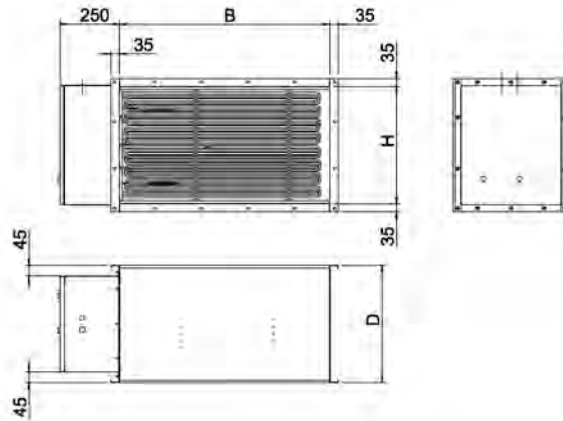
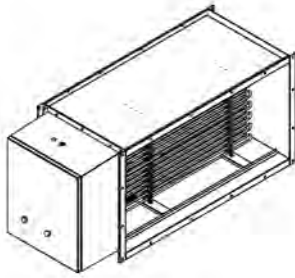

VTL2 – for Plug-in Mounting in Ducts

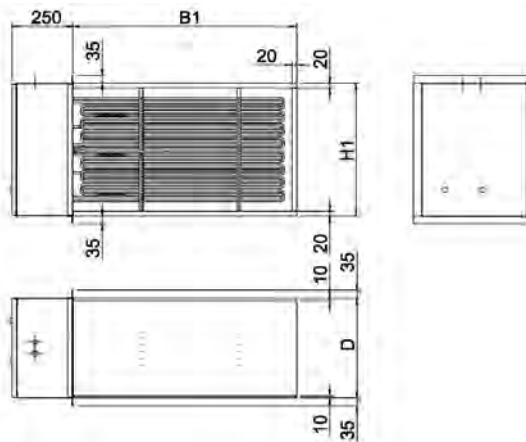
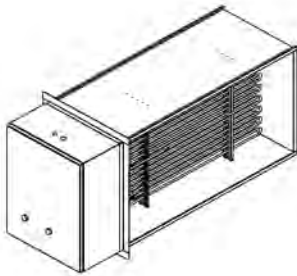

VRA2 – for Units

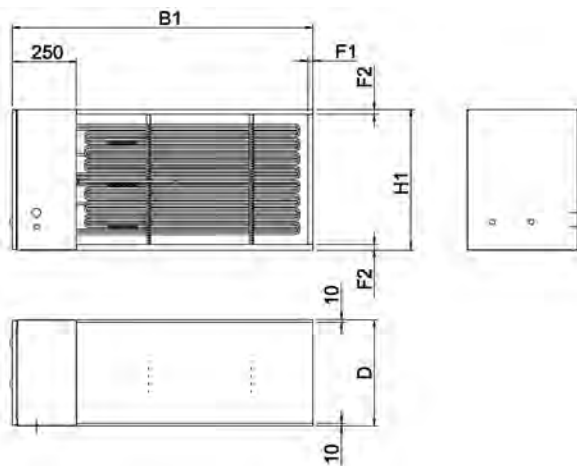
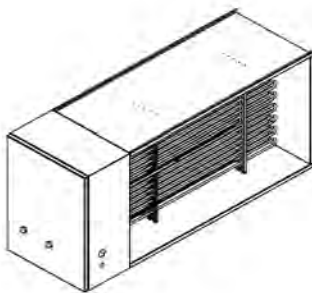

VFL2-Ex / VTL2-Ex / VRA2-Ex

Project Design/Orders

Versions	VFL2-Ex – Heater for flange connection in duct system VTL2-Ex – Heater for plug-in mounting in duct system VRA2-Ex – Heater for air handling units
Model	M = Heater with integrated overheating protection and for external control
Width dimension, W Height dimension, H	200 mm min. 3000 mm max. (open surface for air flow) 200 mm min. 3000 mm max. (open surface for air flow)
Total output kW	Selectable between 1 kW and 1000 kW
Main voltage / max load per output stage	1x 230 V = 1 phase 230 V / 14.5 kW 2x 400 V / 25 kW 3x 230 V / 25 kW 3x 400 V / 43 kW 3x 440 V / 48 kW 3x 460 V / 50 kW 3x 500 V / 54 kW 3x 690 V / 75 kW
Casing material	S = Stainless steel, EN 1.4301 SA = Acid-proof stainless steel, EN 1.4404
Degree of protection	IP66
Electric insulation	NI = Normal electrical insulation
Temperature class	T3 = 200 °C max. on radiating surfaces
Outlet air temperature	40C = Outlet temperature 40 °C max.

Type Designation VFL2-EX

The type designation of a duct heater can, for example, be VFL2-Ex-M-1200-500-80kW-3x400V-S-IP66-NI-T3-40C and describes the product's execution. The type designation is structured as follows:

Design	Model	Width dimension, W	Height dimension, H	Total output kW	Main voltage V	Casing materials	Degree of protection	Electrical insulation	Temperature class	Outlet air temp.
VFL2-EX	M	1200	500	80 kW	3 × 400 V	S	IP66	NI	T3	40C



Type Designation VRA2-Ex and VTL2-Ex

Design	Model	Width dimension, W1	Height dimension, H1	Total output kW	Main voltage V	Casing materials	Degree of protection	Electrical insulation	Temperature class	Outlet air temp.
VRA2-Ex	M	1200	500	80 kW	3 × 400 V	S	IP66	NI	T3	40C

Example of Order Document

Sample text – VFL2-Ex

ATEX-approved duct heater of VEAB type VFL2-Ex-1200x500-80kW-3x400V-M-S-IP66-T3-40C, with casing made of stainless steel EN 1.4301 and heating elements made of stainless material EN 1.4301. Complete with integrated anticondensation heater in the terminal box. The heating elements are installed in a removable magazine.

Marking: Ex II 2 G Ex db eb mb IIC T3 Gb

Air volume: 7000 m³/h.

Width dimension: 1200 mm

Height dimension: 500 mm

Depth dimension: VEAB will specify the depth in the quote and in the order confirmation

Output: 80 kW

Output stages: 40 kW + 40 kW

Voltage: 3x400 V

Model: M

Casing material: Stainless steel EN 1.4301

Degree of protection: IP66

Temperature class: T3 (200 °C max.)

Max. outlet air temperature: 40 °C

Heating element material: EN 1.4301

Anticondensation heater: Yes

Sample text – VTL2-Ex

ATEX-approved duct heater of VEAB type VTL2-Ex-1200x500-80kW-3x400V-M-S-IP66-T3-40C, with casing made of stainless steel EN 1.4301 and heating elements made of stainless material EN 1.4301. Complete with integrated anticondensation heater in the terminal box.

Marking: Ex II 2 G Ex db eb mb IIC T3 Gb

Air volume: 7000 m³/h.

Width dimension: 1200 mm

Height dimension: 500 mm

Depth dimension: VEAB will specify the depth in the quote and in the order confirmation

Output: 80 kW

Output stages: 40 kW + 40 kW

Voltage: 3x400 V

Model: M

Casing material: Stainless steel EN 1.4301

Degree of protection: IP66

Temperature class: T3 (200 °C max.)

Max. outlet air temperature: 40 °C

Heating element material: EN 1.4301

Anticondensation heater: Yes

Sample text – VRA2-Ex

ATEX-approved duct heater of VEAB type VRA2-Ex-1200x500-80kW-3x400V-M-S-IP66-T3-40C, with casing made of stainless steel EN 1.4301 and heating elements made of stainless material EN 1.4301. Complete with integrated anticondensation heater in the terminal box.

Marking: Ex II 2 G Ex db eb mb IIC T3 Gb

Air volume: 7000 m³/h.

Width dimension: 1200 mm

Height dimension: 500 mm

Depth dimension: VEAB will specify the depth in the quote and in the order confirmation

Output: 80 kW

Output stages: 40 kW + 40 kW

Voltage: 3x400 V

Model: M

Casing material: Stainless steel EN 1.4301

Degree of protection: IP66

Temperature class: T3 (200 °C max.)

Max. outlet air temperature: 40 °C

Heating element material: EN 1.4301

Anticondensation heater: Yes

Connection Diagram

Wiring example 1
230 VAC 1-ph. and 400 VAC 2-ph.

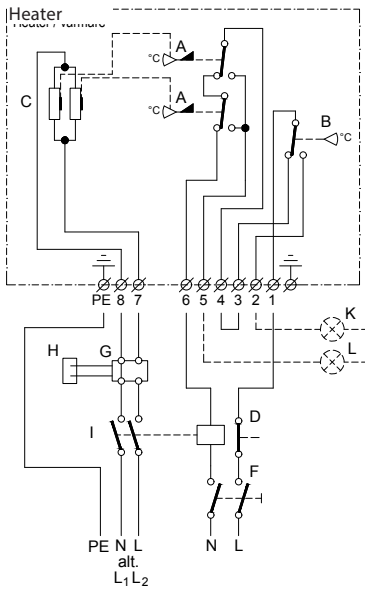

Wiring example 2
43 kW max., 400 VAC 3-ph. (63 A)

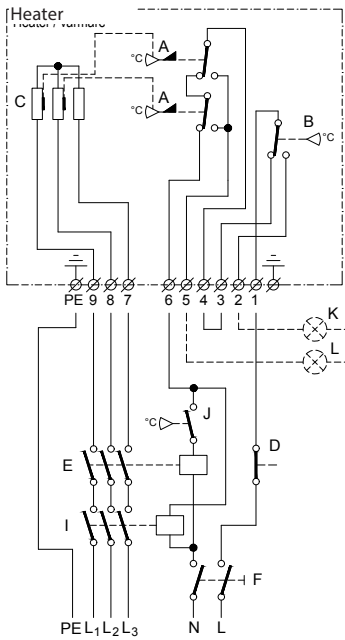

Wiring example 3
43 kW max., 400 VAC 3-ph. (63 A)
with anticondensation heater

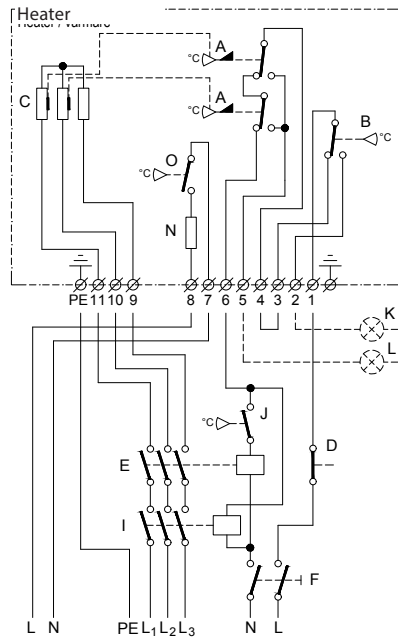

Wiring example 4
129 kW max., 400 VAC 3-ph., 3 output stages ($\frac{1}{3}+\frac{1}{3}+\frac{1}{3}$)

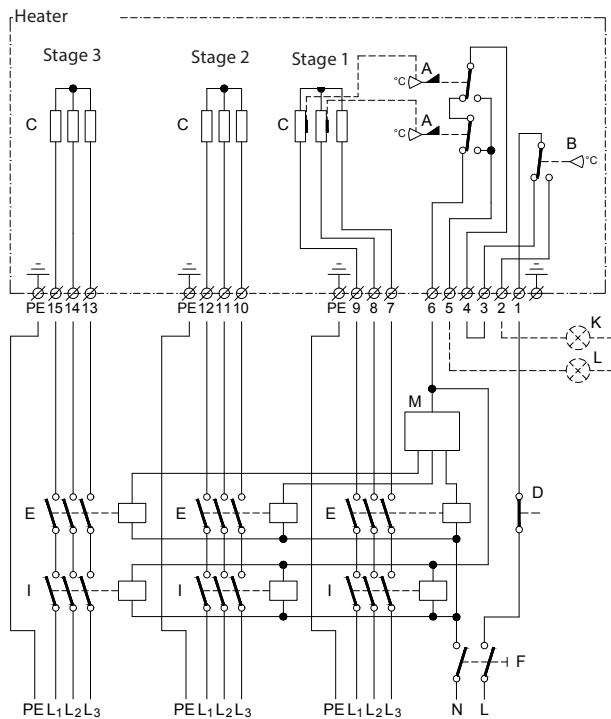

Wiring example 5 with thyristor control
129 kW max., 400 VAC 3-ph., 3 output stages ($\frac{1}{3}+\frac{1}{3}+\frac{1}{3}$)

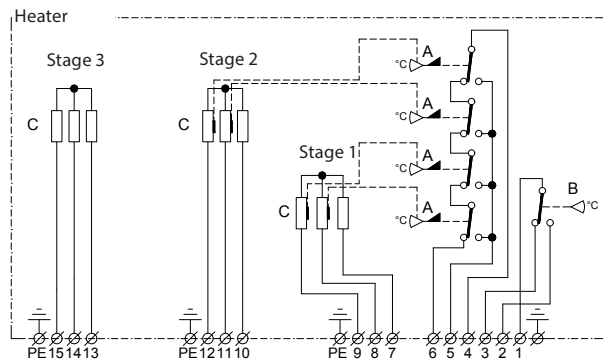

- A 2 temperature limiters with manual reset that limit the surface temperature of the heating elements. Mounted on heating elements in output stage 1.
- B Thermostat for limitation of outlet air temperature
- C Load
- D Interlock
- E Contactor
- F Omnipolar circuit breaker
- G Output control
- H Sensors
- I Safety contactor
- J Thermostat
- K Signal, high outlet temperature
- L Signal, triggered temperature limiters
- M Regulator
- N Thermostat feedback control
- O Anticondensation heater, 50 W



VEAB Heat Tech AB
Tel +46(0)451-485 00
www.veab.com • veab@veab.com
Sweden



CWW / CFW
Circular duct heaters for hot water

CWW

Circular duct heaters for hot water

CWW duct heaters with circular duct connection use hot water as energy medium and are used to heat the ventilation air in a ventilation system. CWW duct heaters can also be used for individual heating of specific rooms or areas. To regulate the room or inlet air temperature, the duct heaters are complemented with regulators, sensors, actuators, valves and a frost-protection control.

- 15 standard sizes in stock
- Opening access panel for inspection and cleaning
- Coil, 2 or 3 rows of pipes
- Air tightness class C as per EN 15727

Design

Casing made of aluzinc-coated sheet steel, AZ 185. Coil with copper pipes and pipe connections as well as aluminium fins. Opening access panel for easy inspection and cleaning. Duct connections are fitted with rubber gaskets.

Operating Data

Max. operating temperature: +150 °C
 Max. operating pressure: 1.0 MPa (10 bar)
 The coils have been pressurised and leak tested.

Dimensioning

Dimensioning can easily be achieved with our web-based calculation program VEAB Select (www.veab.com). If necessary, contact our sales staff for help.

Installation

CWW duct heaters can be installed in a horizontal or a vertical duct with the air flow in any direction.

Control Unit

See pages 6 to 8 for a list of regulators, sensors, valves and actuators.

Hygiene

The design with an opening access panel allows for inspection and cleaning of coil and air channels. This contributes to cleaner air channels and thus fresh and healthy ventilation air.



Air Tightness Class C

CWW duct heaters meet air tightness class C as per EN 15727, which ensures that the heated air reaches its destination and does not leak out of the ventilation system—that saves both energy and money.



Product Range Overview with Dimensional Drawing

Type	Ø D mm	B mm	H mm	Ø dy mm	F mm	G mm	K mm	L mm	Inner pipe volume l	Weight kg
CWW 100-2-2.5	100	251	180	10	137	30	280	340	0.1	3.6
CWW 100-3-2.5	100	251	180	10	100	30	280	340	0.15	3.6
CWW 125-2-2.5	125	251	180	10	137	35	280	350	0.1	3.6
CWW 125-3-2.5	125	326	255	10	175	35	280	350	0.4	5.2
CWW 160-2-2.5	160	326	255	10	212	40	280	360	0.25	5.4
CWW 160-3-2.5	160	326	255	10	175	40	280	360	0.4	5.4
CWW 200-2-2.5	200	326	255	10	212	40	280	360	0.25	5.3
CWW 200-3-2.5	200	411	330	22	250	40	280	360	0.7	8.2
CWW 250-2-2.5	250	411	330	22	250	40	280	360	0.45	7.7
CWW 250-3-2.5	250	486	405	22	325	40	280	360	1.1	10.2
CWW 315-2-2.5	315	486	405	22	325	40	280	360	0.7	9.9
CWW 315-3-2.5	315	560	504	22	400	40	280	360	1.61	13.4
CWW 400-2-2.5	400	560	504	22	400	55	280	390	1.0	13.1
CWW 400-3-2.5	400	710	529	22	425	55	332	442	2.5	17.9
CWW 500-2-2.5	500	707	529	22	425	55	332	442	1.6	16.9

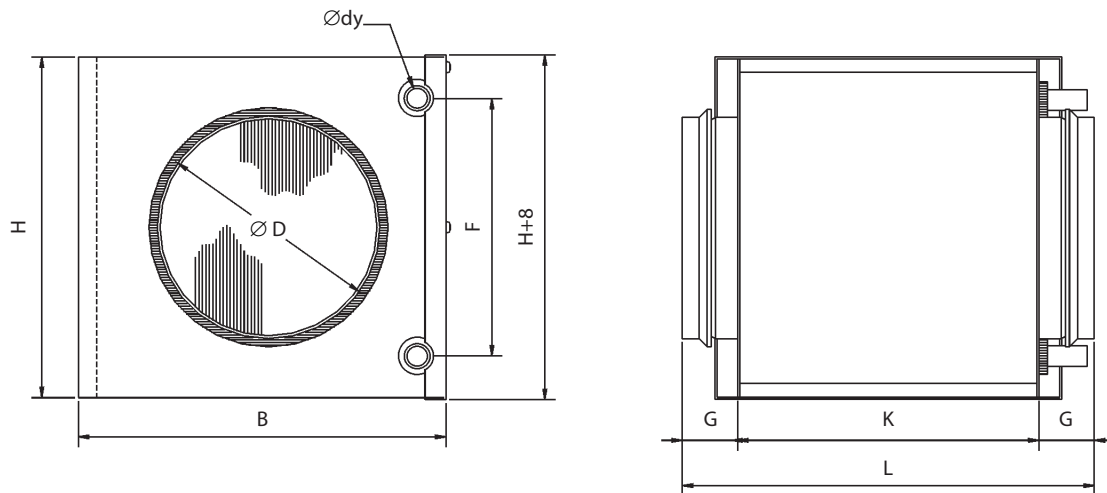

Project Design/Orders

Description – CWW

Duct heater, VEAB type CWW, with casing made of aluzinc-coated sheet steel, AZ 185, coil with copper pipes and pipe connections as well as aluminium fins. The duct heater meets air tightness class C.

Feedback control is achieved by means of an external regulator, sensors, valves and actuators to be ordered separately.

Type designation CWW 100 - 2 - 2.5

(example)

Size designation

Number of rows of pipes

Fin spacing mm

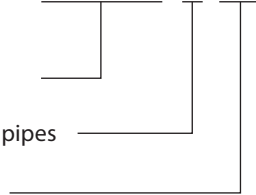

Specify the following when configuring/ordering

1. Air flow: - m³/h
2. Inlet air temperature: - °C
3. Outlet air temp. or desired output: - °C or kW
4. Duct dimensions: - mm
5. Inlet water temperature: - °C
6. Outlet water temp. or water flow: - °C or l/s
7. Antifreeze agent: - type / %

CFW

Circular duct heaters for hot water, Insulated

CFW duct heaters with circular duct connection use hot water as energy medium and are used to heat the ventilation air in a ventilation system. CFW duct heaters can also be used for individual heating of specific rooms or areas. To regulate the room or inlet air temperature, the duct heaters are complemented with regulators, sensors, actuators, valves and a frost-protection control.

CFW is supplied with a double-jacket casing and insulated with 50 mm rock wool. The insulation minimises energy dissipation.

CFW has an insulated opening access panel making it easy to clean the coil and air channels. Regular cleaning ensures efficiency, and is important for hygiene.

- 13 standard sizes in stock
- Double-jacket casing made of aluzinc-coated sheet steel, AZ 185
- Insulated with 50 mm rock wool
- Opening access panel for inspection and cleaning
- Coil, 2 or 3 rows of pipes
- Air tightness class C as per EN 15727

Design

Double-jacket casing made of aluzinc-coated sheet steel, AZ 185 with 50 mm rock wool insulation. Coil with copper pipes and pipe connections as well as aluminium fins.

Duct connections are fitted with rubber gaskets.

Operating Data

Max. operating temperature: +150 °C
 Max. operating pressure: 1.0 MPa (10 bar)
 The coils have been pressurised and leak tested.

Dimensioning

Dimensioning can easily be achieved with our web-based calculation program VEAB Select (www.veab.com). If necessary, contact our sales staff for help.

Installation

CFW duct heaters can be installed in a horizontal or a vertical duct with the air flow in any direction.

Control Unit

See pages 6 to 8 for a list of regulators, sensors, valves and actuators.

Hygiene

The design with an opening access panel allows for inspection and cleaning of coil and air channels. This contributes to cleaner air channels and thus fresh and healthy ventilation air.



Air Tightness Class C

CFW duct heaters meet air tightness class C as per EN 15727, which ensures that the heated air reaches its destination and does not leak out of the ventilation system—that saves both energy and money.



Product Range Overview with Dimensional Drawing

Type	∅ D mm	B mm	H mm	∅ dy mm	F mm	G mm	K mm	L mm	Inner pipe volume l	Weight kg
CFW 125-2-2.5	125	329	253	10	137	35	366	436	0.1	9.5
CFW 125-3-2.5	125	404	328	10	175	35	366	436	0.4	13.8
CFW 160-2-2.5	160	404	328	10	212	40	368	448	0.25	14.4
CFW 160-3-2.5	160	404	328	10	175	40	368	448	0.4	14.4
CFW 200-2-2.5	200	404	328	10	212	40	368	448	0.25	14
CFW 200-3-2.5	200	489	403	22	250	40	368	448	0.7	21.8
CFW 250-2-2.5	250	489	403	22	250	40	380	460	0.45	20.5
CFW 250-3-2.5	250	564	478	22	325	40	380	460	1.1	26.5
CFW 315-2-2.5	315	564	478	22	325	40	382	462	0.7	25.7
CFW 315-3-2.5	315	639	553	22	400	40	382	462	1.6	28.8
CFW 400-2-2.5	400	639	553	22	400	55	380	490	1.0	28.1
CFW 400-3-2.5	400	789	581	22	425	55	380	490	2.5	38
CFW 500-2-2.5	500	789	651	22	425	55	378	488	1.6	42

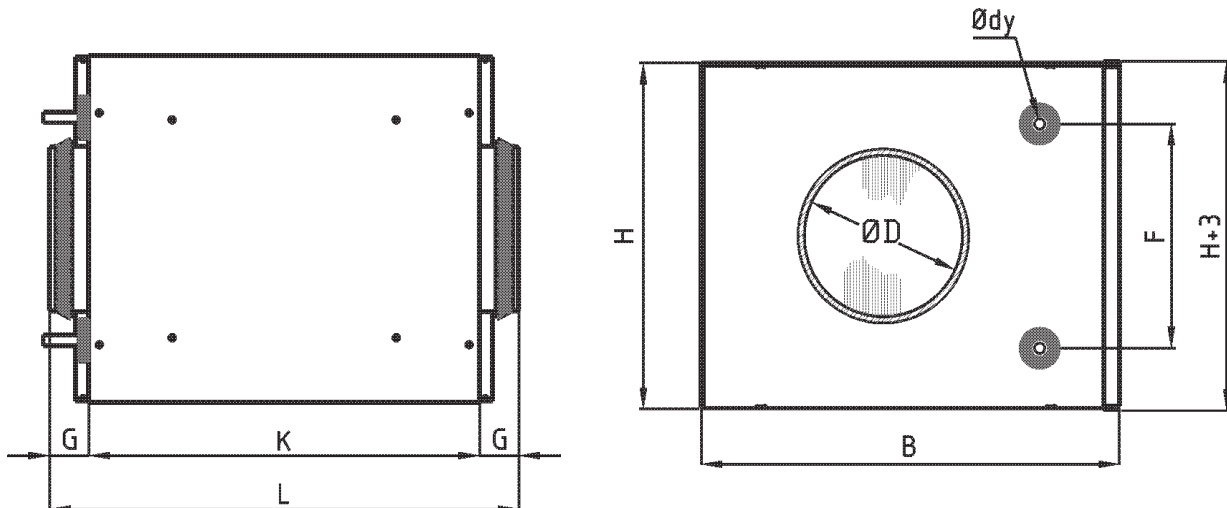

Project Design/Orders

Description – CFW

Duct heater, VEAB type CFW, with 50 mm rock wool insulated double-jacket casing made of aluzinc-treated sheet steel, AZ 185, coil with copper pipes and pipe connections as well as aluminium fins. The duct heater meets air tightness class C.

Feedback control is achieved by means of an external regulator, sensors, valves and actuators to be ordered separately.

Type designation CFW 125 - 2 - 2.5

(example)

Size designation

Number of rows of pipes

Fin spacing mm

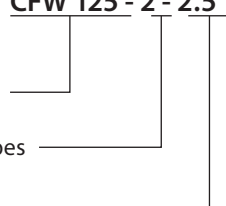

Specify the following when configuring/ordering

1. Air flow: - m³/h
2. Inlet air temperature: - °C
3. Outlet air temp. or desired output: - °C or kW
4. Duct dimensions: - mm
5. Inlet water temperature: - °C
6. Outlet water temp. or water flow: - °C or l/s
7. Antifreeze agent: - type / %

Regulators



AQUA24TF



RC



RC-DO



OPTIGO OP10

AQUA

Complete regulator with integrated room sensor. Floating feedback control for control of three-position actuators. Cascade connection with minimum limitation of inlet air in case of room feedback control. Can be fitted with external room and/or duct sensor as well as external setpoint adjuster. Temperature range 0-30 °C, depending on choice of sensor.

AQUA24TF

24 V supply. The regulator includes an integrated regulating antifreeze device with two alarm relays and automation for standstill heater.

REGIO MINI

Complete regulator with integrated room sensor. Can be fitted with external room and/or duct sensor. Includes two control outputs for sequential heating and cooling, for example.

RC

24 V supply. 0...10 V outgoing control signal. Base setpoint 20-26 °C is adjusted with DIP switches. The base setpoint can be adjusted by ± 3 °C using the setpoint knob.

RC-DO

24 V supply. 0...10 V outgoing control signal. RC-DO includes a backlighted display and temperature range from 0-50 °C.

OPTIGO

Regulator with display. One knob for all adjustments. To be mounted on DIN rail. Operates with PT1000 sensor Within the -20 °C to +40 °C range. Started/stopped with "run" signal from fan.

OP5

24 V supply. 0...10 V outgoing control signal. Operates with a room or duct sensor. Convertible for heating or cooling feedback control.







OP10

24 V supply. Adjustable for 0...10 V outgoing control signal or 3-point feedback control. Two control outputs for sequential heating and cooling, for example. Input for two sensors and possible antifreeze sensor. Inlet air feedback control or room feedback control with cascade controlled inlet air. Antifreeze control with standstill heater. Output for starting/stopping fans, for example, via relay 230 VAC 1-ph., 5 A. Programmable weekly timer for control of both fans and heating/cooling. Outputs for external timer that extends operating time. Can be equipped with an external setpoint adjuster.





OP10-230

Same functions as OP10 but with 230 VAC 1-ph supply.

AQUA Accessories

	Product	Range	Design
	Duct sensor TG-K330	0-30 °C	IP20 degree of protection
	Room sensor TG-R430 With setpoint adjuster	0-30 °C	IP30 degree of protection
	Room Sensors TG-R530	0-30 °C	IP30 degree of protection
	Room sensor TG-R630	0-30 °C	IP54 degree of protection
	Strap-on temperature sensor TG-A130 Supplied with clamp	0-30 °C	IP65 degree of protection
	Transformer 60 Enclosed transformer for wall mounting. Integrated two-pole protection on secondary side.		Input voltage 230 VAC 1-ph. Output voltage 24 VAC 1-ph. Maximum load 60 VA IP44 degree of protection

OPTIGO and REGIO Accessories

	Product	Range	Design
	Duct sensor TG-K3/PT1000	-30...+70 °C	IP20 degree of protection
	Room sensor TG-R5/PT1000	0-50 °C	IP30 degree of protection
	Room sensor TG-UH/PT1000	-30...+120 °C	IP65 degree of protection
	Strap-on temperature sensor TG-A1/PT1000 Supplied with clamp	-30...+150 °C	IP65 degree of protection
	Transformer 60 Enclosed transformer for wall mounting. Integrated two-pole protection on secondary side.		Input voltage 230 VAC 1-ph. Output voltage 24 VAC 1-ph. Maximum load 60 VA IP44 degree of protection

Actuators and Valves with Kvs 0.25 – 8.0 (110 °C max.)

Designation		Type
3-way actuator for ZTV/ZTR valves, IP44 degree of protection		RVAZ4-24
0...10 V actuators for ZTV/ZTR valves, IP44 degree of protection		RVAZ4-24A
Designation	Kvs	Type
2-way valve ½"	0.25	ZTV15-0,25
2-way valve ½"	0.4	ZTV15-0,4
2-way valve ½"	0.6	ZTV15-0,6
2-way valve ½"	1.0	ZTV15-1,0
2-way valve ½"	1.6	ZTV15-1,6
2-way valve ¾"	2.0	ZTV20-2,0
2-way valve ¾"	2.5	ZTV20-2,5
2-way valve ¾"	4.0	ZTV20-4,0
2-way valve ¾"	6.0	ZTV20-6,0
2-way valve 1"	8.0	ZTVB25-8
3-way valve ½"	0.25	ZTR15-0,25
3-way valve ½"	0.4	ZTR15-0,4
3-way valve ½"	0.6	ZTR15-0,6
3-way valve ½"	1.0	ZTR15-1,0
3-way valve ½"	1.6	ZTR15-1,6
3-way valve ¾"	2.0	ZTR20-2,0
3-way valve ¾"	2.5	ZTR20-2,5
3-way valve ¾"	4.0	ZTR20-4,0
3-way valve ¾"	6.0	ZTR20-6,0
3-way valve 1"	8.0	ZTRB25-8



RVAZ4-24 actuator



ZTV valve



ZTR valve



RVAN5-24 actuator



MTVS valve



MTRS valve

Actuators and Valves with Kvs 1.0 – 16.0 (185°C max.)

Designation		Type
3-way actuator for MTRV/MTRS valves, IP54 degree of protection		RVAN5-24
0...10 V actuators for MTRV/MTRS valves, IP54 degree of protection		RVAN5-24A
Designation	Kvs	Type
2-way valve ½"	1.0	MTRV15-1,0
2-way valve ½"	1.6	MTRV15-1,6
2-way valve ½"	2.1	MTRV15-2,1
2-way valve ½"	2.7	MTRV15-2,7
2-way valve ¾"	4.2	MTRV20-4,2
2-way valve ¾"	5.6	MTRV20-5,6
2-way valve 1"	10.0	MTRV25-10
2-way valve 1 ¼"	16.0	MTRV32-16
3-way valve ½"	0.63	MTRS15-0,63
3-way valve ½"	1.0	MTRS15-1,0
3-way valve ½"	1.6	MTRS15-1,6
3-way valve ½"	2.1	MTRS15-2,1
3-way valve ½"	2.7	MTRS15-2,7
3-way valve ¾"	4.2	MTRS20-4,2
3-way valve ¾"	5.6	MTRS20-5,6
3-way valve 1"	10.0	MTRS25-10
3-way valve 1 ¼"	16.0	MTRS32-16

Valve and Actuator Selection Guide for CWW / CFW

Water temp. 110 °C max.

Actuators RVAZ4-24 (3-position) or RVAZ4-24A (0...10 V) can be used for all ZTV/ZTR valves.

Type of CWW / CFW	Valve type	Kvs
CWW 100-2-2.5	2-way ZTV15-0.4 3-way ZTR15-0.4	0.4
CWW 100-3-2.5	2-way ZTV15-0.4 3-way ZTR15-0.4	0.4
CWW 125-2-2.5 CFW 125-2-2.5	2-way ZTV15-0.6 3-way ZTR15-0.6	0.6
CWW 125-3-2.5 CFW 125-3-2.5	2-way ZTV15-0.4 3-way ZTR15-0.4	0.4
CWW 160-2-2.5 CFW 160-2-2.5	2-way ZTV15-0.6 3-way ZTR15-0.6	0.6
CWW 160-3-2.5 CFW 160-3-2.5	2-way ZTV15-0.4 3-way ZTR15-0.4	0.4
CWW 200-2-2.5 CFW 200-2-2.5	2-way ZTV15-0.6 3-way ZTR15-0.6	0.6
CWW 200-3-2.5 CFW 200-3-2.5	2-way ZTV15-1.0 3-way ZTR15-1.0	1.0
CWW 250-2-2.5 CFW 250-2-2.5	2-way ZTV15-1.6 3-way ZTR15-1.6	1.6
CWW 250-3-2.5 CFW 250-3-2.5	2-way ZTV15-1.6 3-way ZTR15-1.6	1.6
CWW 315-2-2.5 CFW 315-2-2.5	2-way ZTV15-1.6 3-way ZTR15-1.6	1.6
CWW 315-3-2.5 CFW 315-3-2.5	2-way ZTV15-1.6 3-way ZTR15-1.6	1.6
CWW 400-2-2.5 CFW 400-2-2.5	2-way ZTV20-2.5 3-way ZTR20-2.5	2.5
CWW 400-3-2.5 CFW 400-3-2.5	2-way ZTV20-2.5 3-way ZTR20-2.5	2.5
CWW 500-2-2.5 CFW 500-2-2.5	2-way ZTV20-4.0 3-way ZTR20-4.0	4.0

Water temp. 185 °C max.

Actuators RVAN5-24 (3-position) or RVAN5-24A (0...10 V) can be used for all MTVS/MTRS valves.

Type of CWW / CFW	Valve type	Kvs
CWW 100-2-2.5	2-way MTVS15-1.0	1.0
CWW 100-3-2.5	2-way MTVS15-1.0	1.0
CWW 125-2-2.5 CFW 125-2-2.5	2-way MTVS15-1.0	1.0
CWW 125-3-2.5 CFW 125-3-2.5	2-way MTVS15-1.0	1.0
CWW 160-2-2.5 CFW 160-2-2.5	2-way MTVS15-1.0	1.0
CWW 160-3-2.5 CFW 160-3-2.5	2-way MTVS15-1.0	1.0
CWW 200-2-2.5 CFW 200-2-2.5	2-way MTVS15-1.0	1.0
CWW 200-3-2.5 CFW 200-3-2.5	2-way MTVS15-1.0	1.0
CWW 250-2-2.5 CFW 250-2-2.5	2-way MTVS15-1.0	1.0
CWW 250-3-2.5 CFW 250-3-2.5	2-way MTVS15-1.6 3-way MTRS15-1.6	1.6
CWW 315-2-2.5 CFW 315-2-2.5	2-way MTVS15-1.6 3-way MTRS15-1.6	1.6
CWW 315-3-2.5 CFW 315-3-2.5	2-way MTVS15-1.6 3-way MTRS15-1.6	1.6
CWW 400-2-2.5 CFW 400-2-2.5	2-way MTVS15-2.1 3-way MTRS15-2.1	2.1
CWW 400-3-2.5 CFW 400-3-2.5	2-way MTVS15-2.7 3-way MTRS15-2.7	2.7
CWW 500-2-2.5 CFW 500-2-2.5	2-way MTVS15-2.7 3-way MTRS15-2.7	2.7

CWW / CFW

Pressure Drop Chart for Valves

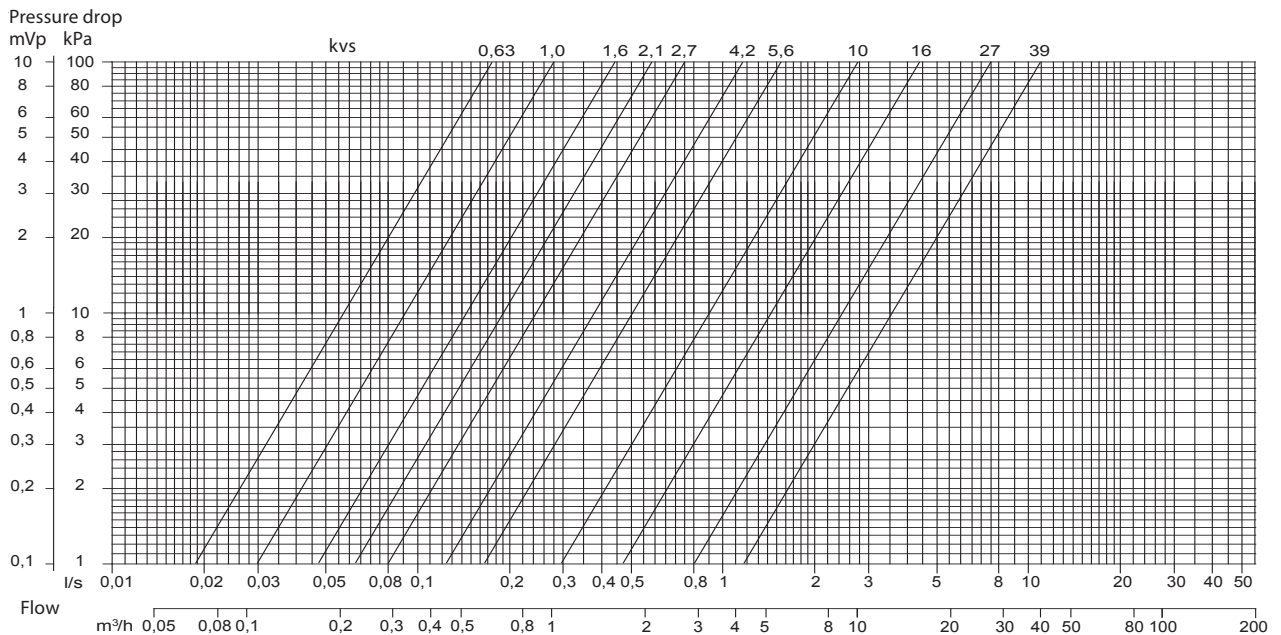



VEAB Heat Tech AB
Tel +46(0)451-485 00
www.veab.com • veab@veab.com
Sweden



PGV
Rectangular duct heaters
for hot water

PGV

Rectangular duct heaters for hot water

PGV duct heaters with rectangular duct connection use hot water as energy medium and are used to heat the ventilation air in a ventilation system. PGV duct heaters can also be used as fresh air heater units. To regulate the room or inlet air temperature, the duct heaters are complemented with regulators, sensors, actuators, valves and a frost-protection control.

- 23 standard sizes in stock
- Nipples for draining and venting
- Coil with copper pipes and aluminium fins
- Internally threaded connection for installation of antifreeze sensors
- Air tightness class C as per EN 15727

Design

The casing is made of hot-dip galvanised sheet steel Magnelis ZM200.

Coil with copper pipes and aluminium fins.

The duct heater is also equipped with nipples for draining and venting as well as an internally threaded connection for installation of antifreeze sensors.



Operating Data

Max. operating temperature: +150 °C
 Max. operating pressure: 1.0 MPa (10 bar)
 The coils have been pressurised and leak tested.

Capacity

Dimensioning can easily be achieved with our web-based calculation program VEAB Select (www.veab.com). If necessary, contact our sales staff for help.

Installation

PGV duct heaters can be installed in a horizontal or a vertical duct with the air flow in any direction.

Control Unit

See pages 4 to 6 for a list of regulators, sensors, valves and actuators.

Air Tightness Class C

PGV duct heaters meet air tightness class C as per EN 15727, which ensures that the heated air reaches its destination and does not leak out of the ventilation system—that saves both energy and money.



Product Range Overview with Dimensional Drawing

Type	B mm	H mm	I mm	K mm	M mm	N conn. R	Inner pipe volume l
PGV 250x150-2-2,5	288	188	113	84	22	1/2"	0.32
PGV 400x200-2-2,5	438	238	150	63	43	3/4"	0.7
PGV 400x200-4-2,5	438	238	150	63	65	3/4"	1.2
PGV 500x250-2-2,5	538	288	200	63	43	3/4"	0.8
PGV 500x250-4-2,5	538	288	200	63	65	3/4"	1.4
PGV 500x300-2-2,5	538	338	250	63	43	3/4"	1.2
PGV 500x300-4-2,5	538	338	250	63	65	1"	2.2
PGV 500x400-2-2,5	538	438	350	63	43	3/4"	1.5
PGV 500x400-4-2,5	538	438	350	61	47	1"	3.0
PGV 600x300-2-2,5	638	338	250	63	43	3/4"	1.3
PGV 600x300-4-2,5	638	338	250	63	65	1"	2.6
PGV 600x350-2-2,5	638	388	300	63	43	3/4"	1.5
PGV 600x350-4-2,5	638	388	300	63	65	1"	3.0
PGV 700x400-2-2,5	738	438	350	61	47	1"	2.5
PGV 700x400-3-2,5	738	438	350	66	58	1"	3.5
PGV 800x400-2-2,5	838	438	350	61	47	1"	2.7
PGV 800x400-3-2,5	838	438	350	66	58	1"	3.9
PGV 800x500-2-2,5	838	538	450	61	47	1"	3.4
PGV 800x500-3-2,5	838	538	450	66	58	1"	4.9
PGV 1000x500-2-2,5	1038	538	450	61	47	1"	4.1
PGV 1000x500-3-2,5	1038	538	450	66	58	1"	5.9
PGV 1200x600-2-2,5	1238	638	545	61	47	1"	5.7
PGV 1200x600-3-2,5	1238	638	545	66	58	1 1/4"	8.6

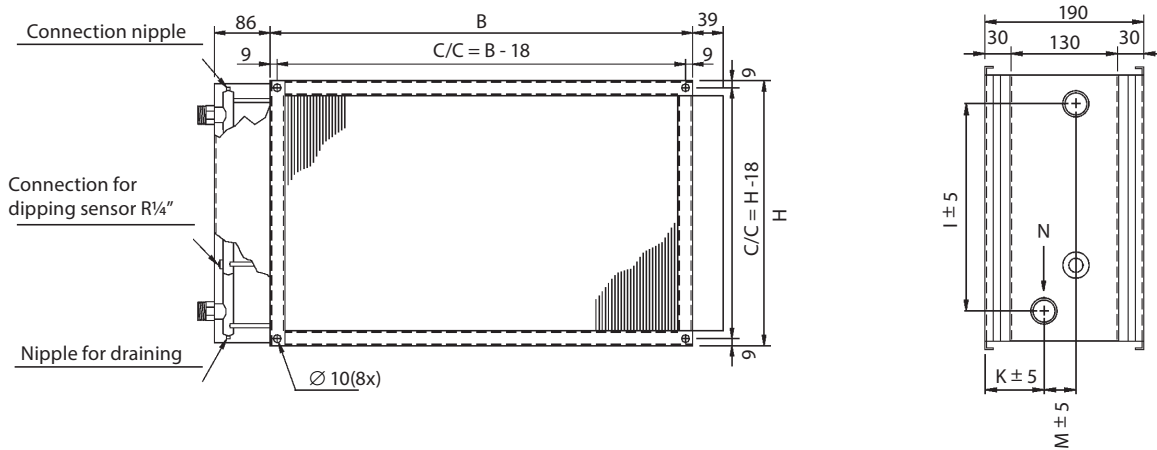

Project Design/Orders

Description – PGV

Duct heater, VEAB type PGV, with casing made of hot-dip galvanised sheet steel Magnelis, coil with copper pipes and pipe connections as well as aluminium fins. The duct heater meets air tightness class C. Feedback control is achieved by means of an external regulator, sensors, valves and actuators to be ordered separately.

Type designation PGV 400x200 - 2 - 2.5

(example)

Size designation

Number of rows of pipes

Fin spacing mm

Specify the following when configuring/ ordering

1. Air flow: - m³/h
2. Inlet air temperature: - °C
3. Outlet air temp. or desired output: - °C or kW
4. Duct dimensions: - mm
5. Inlet water temperature: - °C
6. Outlet water temp. or water flow: - °C or l/s
7. Antifreeze agent: - type / %

Regulators



AQUA24TF



RC



RC-DO



OPTIGO OP10

AQUA

Complete regulator with integrated room sensor. Floating feedback control for control of three-position actuators. Cascade connection with minimum limitation of inlet air in case of room feedback control. Can be fitted with external room and/or duct sensor as well as external setpoint adjuster. Temperature range 0-30 °C, depending on choice of sensor.

AQUA24TF

24 V supply. The regulator includes an integrated regulating antifreeze device with two alarm relays and automation for standstill heater.

REGIO MINI

Complete regulator with integrated room sensor. Can be fitted with external room and/or duct sensor. Includes two control outputs for sequential heating and cooling, for example.

RC

24 V supply. 0...10 V outgoing control signal. Base setpoint 20-26 °C is adjusted with DIP switches. The base setpoint can be adjusted by ± 3 °C using the setpoint knob.

RC-DO

24 V supply. 0...10 V outgoing control signal. RC-DO includes a backlighted display and temperature range from 0-50 °C.

OPTIGO

Regulator with display. One knob for all adjustments. To be mounted on DIN rail. Operates with PT1000 sensor within the -20 °C to +40 °C range. Started/stopped with "run" signal from fan.

OP5

24 V supply. 0...10 V outgoing control signal. Operates with a room or duct sensor. Convertible for heating or cooling feedback control.









OP10

24 V supply. Adjustable for 0...10 V outgoing control signal or 3-point feedback control. Two control outputs for sequential heating and cooling, for example. Input for two sensors and possible antifreeze sensor. Inlet air feedback control or room feedback control with cascade controlled inlet air. Antifreeze control with standstill heater. Output for starting/stopping fans, for example, via relay 230 VAC 1-ph., 5 A. Programmable weekly timer for control of both fans and heating/cooling. Outputs for external timer that extends operating time. Can be equipped with an external setpoint adjuster.







OP10-230

Same functions as OP10 but with 230 VAC 1-ph supply.

AQUA Accessories

	Product	Range	Design
	Duct sensor TG-K330	0-30 °C	IP20 degree of protection
	Room sensor TG-R430 With setpoint adjuster	0-30 °C	IP30 degree of protection
	Room sensor TG-R530	0-30 °C	IP30 degree of protection
	Room sensor TG-R630	0-30 °C	IP54 degree of protection
	Strap-on temperature sensor TG-A130 Supplied with clamp	0-30 °C	IP65 degree of protection
	Dipping sensor TG-D130 made of stainless steel for water temp. measurement	0-30 °C	Connection R $\frac{1}{4}$ " Diameter \varnothing 6 mm Insertion length 135 mm IP65 degree of protection
	Dipping sensor TG-D230 made of stainless steel for water temp. measurement	0-30 °C	Connection R $\frac{1}{4}$ " Diameter \varnothing 6 mm Insertion length 220 mm IP65 degree of protection
	Transformer 60 Enclosed transformer for wall mounting. Integrated two-pole protection on secondary side.		Input voltage 230 VAC 1-ph. Output voltage 24 VAC 1-ph. Maximum load 60 VA IP44 degree of protection

OPTIGO and REGIO Accessories

	Product	Range	Design
	Duct sensor TG-K3/PT1000	-30...+70 °C	IP20 degree of protection
	Room sensor TG-R5/PT1000	0-50 °C	IP30 degree of protection
	Room sensor TG-UH/PT1000	-30...+120 °C	IP65 degree of protection
	Strap-on temperature sensor TG-A1/PT1000 Supplied with clamp	-30...+150 °C	IP65 degree of protection
	Dipping sensor TG-D1/PT1000 made of stainless steel for water temp. measurement	-30...+150 °C	Connection R $\frac{1}{4}$ " Diameter \varnothing 4 mm Insertion length 135 mm IP65 degree of protection
	Dipping sensor TG-D2/PT1000 made of stainless steel for water temp. measurement	-30...+150 °C	Connection R $\frac{1}{4}$ " Diameter \varnothing 4 mm Insertion length 220 mm IP65 degree of protection
	Transformer 60 Enclosed transformer for wall mounting. Integrated two-pole protection on secondary side.		Input voltage 230 VAC 1-ph. Output voltage 24 VAC 1-ph. Maximum load 60 VA IP44 degree of protection

Actuators and Valves with Kvs 0.25 – 8.0 (110 °C max.)

Designation		Type
3-way actuator for ZTV/ZTR valves, IP44 degree of protection		RVAZ4-24
0...10 V actuators for ZTV/ZTR valves, IP44 degree of protection		RVAZ4-24A
Designation	Kvs	Type
2-way valve ½"	0.25	ZTV15-0,25
2-way valve ½"	0.4	ZTV15-0,4
2-way valve ½"	0.6	ZTV15-0,6
2-way valve ½"	1.0	ZTV15-1,0
2-way valve ½"	1.6	ZTV15-1,6
2-way valve ¾"	2.0	ZTV20-2,0
2-way valve ¾"	2.5	ZTV20-2,5
2-way valve ¾"	4.0	ZTV20-4,0
2-way valve ¾"	6.0	ZTV20-6,0
2-way valve 1"	8.0	ZTVB25-8
3-way valve ½"	0.25	ZTR15-0,25
3-way valve ½"	0.4	ZTR15-0,4
3-way valve ½"	0.6	ZTR15-0,6
3-way valve ½"	1.0	ZTR15-1,0
3-way valve ½"	1.6	ZTR15-1,6
3-way valve ¾"	2.0	ZTR20-2,0
3-way valve ¾"	2.5	ZTR20-2,5
3-way valve ¾"	4.0	ZTR20-4,0
3-way valve ¾"	6.0	ZTR20-6,0
3-way valve 1"	8.0	ZTRB25-8



RVAZ4-24 actuator



ZTV valve



ZTR valve



RVAN5-24 actuator



MTVS valve



MTRS valve

Actuators and Valves with Kvs 1.0 – 16.0 (150°C max.)

Designation		Type
3-way actuator for MTVS/MTRS valves, IP54 degree of protection		RVAN5-24
0...10 V actuators for MTVS/MTRS valves, IP54 degree of protection		RVAN5-24A
Designation	Kvs	Type
2-way valve ½"	1.0	MTVS15-1,0
2-way valve ½"	1.6	MTVS15-1,6
2-way valve ½"	2.1	MTVS15-2,1
2-way valve ½"	2.7	MTVS15-2,7
2-way valve ¾"	4.2	MTVS20-4,2
2-way valve ¾"	5.6	MTVS20-5,6
2-way valve 1"	10.0	MTVS25-10
2-way valve 1 ¼"	16.0	MTVS32-16
3-way valve ½"	0.63	MTRS15-0,63
3-way valve ½"	1.0	MTRS15-1,0
3-way valve ½"	1.6	MTRS15-1,6
3-way valve ½"	2.1	MTRS15-2,1
3-way valve ½"	2.7	MTRS15-2,7
3-way valve ¾"	4.2	MTRS20-4,2
3-way valve ¾"	5.6	MTRS20-5,6
3-way valve 1"	10.0	MTRS25-10
3-way valve 1 ¼"	16.0	MTRS32-16

Valve and Actuator Selection Guide for PGV

Water temp. 110 °C max.

Actuators RVAZ4-24 (3-position) or RVAZ4-24A (0...10 V) can be used for all ZTV/ZTR valves.

Type of PGV	Valve type	Kvs
PGV 400×200-2-2.5	2-way ZTV15-1.6 3-way ZTR15-1.6	1.6
PGV 400×200-4-2.5	2-way ZTV20-2.5 3-way ZTR20-2.5	2.5
PGV 500×250-2-2.5	2-way ZTV20-2.5 3-way ZTR20-2.5	2.5
PGV 500×250-4-2.5	2-way ZTV20-2.5 3-way ZTR20-2.5	2.5
PGV 500×300-2-2.5	2-way ZTV20-2.5 3-way ZTR20-2.5	2.5
PGV 500×300-4-2.5	2-way ZTV20-2.5 3-way ZTR20-2.5	2.5
PGV 500×400-2-2.5	2-way ZTV20-2.5 3-way ZTR20-2.5	2.5
PGV 500×400-4-2.5	2-way ZTV20-4.0 3-way ZTR20-4.0	4.0
PGV 600×300-2-2.5	2-way ZTV20-2.5 3-way ZTR20-2.5	2.5
PGV 600×300-4-2.5	2-way ZTV20-4.0 3-way ZTR20-4.0	4.0
PGV 600×350-2-2.5	2-way ZTV20-2.5 3-way ZTR20-2.5	2.5
PGV 600×350-4-2.5	2-way ZTV20-4.0 3-way ZTR20-4.0	4.0
PGV 700×400-2-2.5	2-way ZTV20-6.0 3-way ZTR20-6.0	6.0
PGV 700×400-3-2.5	2-way ZTV20-6.0 3-way ZTR20-6.0	6.0
PGV 800×400-2-2.5	2-way ZTV20-6.0 3-way ZTR20-6.0	6.0
PGV 800×400-3-2.5	2-way ZTV20-8.0 3-way ZTR20-8.0	8.0
PGV 800×500-2-2.5	2-way ZTV20-6.0 3-way ZTR20-6.0	6.0
PGV 800×500-3-2.5	2-way ZTVB25-8.0 3-way ZTRB25-8.0	8.0
PGV 1000×500-2-2.5	2-way ZTVB25-8.0 3-way ZTRB25-8.0	8.0
PGV 1000×500-3-2.5	2-way ZTVB25-8.0 3-way ZTRB25-8.0	8.0
PGV 1200×600-2-2.5	2-way ZTVB32-15 3-way ZTRB32-15	15.0
PGV 1200×600-3-2.5	2-way ZTVB32-15 3-way ZTRB32-15	15.0

Water temp. 150 °C max.

Actuators RVAN5-24 (3-position) or RVAN5-24A (0...10 V) can be used for all MTVS/MTRS valves.

Type of PGV	Valve type	Kvs
PGV 400×200-2-2.5	2-way MTVS15-1.6 3-way MTRS15-1.6	1.6
PGV 400×200-4-2.5	2-way MTVS15-2.7 3-way MTRS15-2.7	2.7
PGV 500×250-2-2.5	2-way MTVS15-1.6 3-way MTRS15-1.6	1.6
PGV 500×250-4-2.5	2-way MTVS15-2.7 3-way MTRS15-2.7	2.7
PGV 500×300-2-2.5	2-way MTVS15-2.7 3-way MTRS15-2.7	2.7
PGV 500×300-4-2.5	2-way MTVS15-2.7 3-way MTRS15-2.7	2.7
PGV 500×400-2-2.5	2-way MTVS15-2.7 3-way MTRS15-2.7	2.7
PGV 500×400-4-2.5	2-way MTVS15-4.2 3-way MTRS15-4.2	4.2
PGV 600×300-2-2.5	2-way MTVS15-2.7 3-way MTRS15-2.7	2.7
PGV 600×300-4-2.5	2-way MTVS20-4.2 3-way MTRS20-4.2	4.2
PGV 600×350-2-2.5	2-way MTVS15-2.7 3-way MTRS15-2.7	2.7
PGV 600×350-4-2.5	2-way MTVS20-4.2 3-way MTRS20-4.2	4.2
PGV 700×400-2-2.5	2-way MTVS20-5.6 3-way MTRS20-5.6	5.6
PGV 700×400-3-2.5	2-way MTVS20-5.6 3-way MTRS20-5.6	5.6
PGV 800×400-2-2.5	2-way MTVS15-5.6 3-way MTRS15-5.6	5.6
PGV 800×400-3-2.5	2-way MTVS15-5.6 3-way MTRS15-5.6	5.6
PGV 800×500-2-2.5	2-way MTVS20-5.6 3-way MTRS20-5.6	5.6
PGV 800×500-3-2.5	2-way MTVS20-5.6 3-way MTRS20-5.6	5.6
PGV 1000×500-2-2.5	2-way MTVS20-5.6 3-way MTRS20-5.6	5.6
PGV 1000×500-3-2.5	2-way MTVS20-5.6 3-way MTRS20-5.6	5.6
PGV 1200×600-2-2.5	2-way MTVS25-10 3-way MTRS25-10	10
PGV 1200×600-3-2.5	2-way MTVS25-10 3-way MTRS25-10	10

Pressure drop **Pressure Drop Chart for Valves**

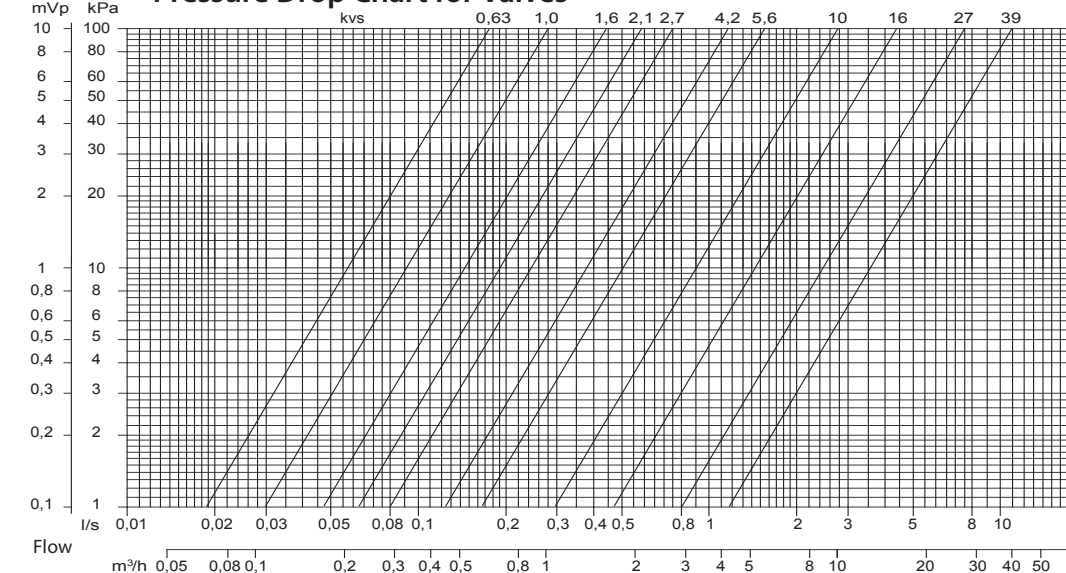



VEAB Heat Tech AB
Tel.: +46(0)451-485 00
www.veab.com • veab@veab.com
Sweden

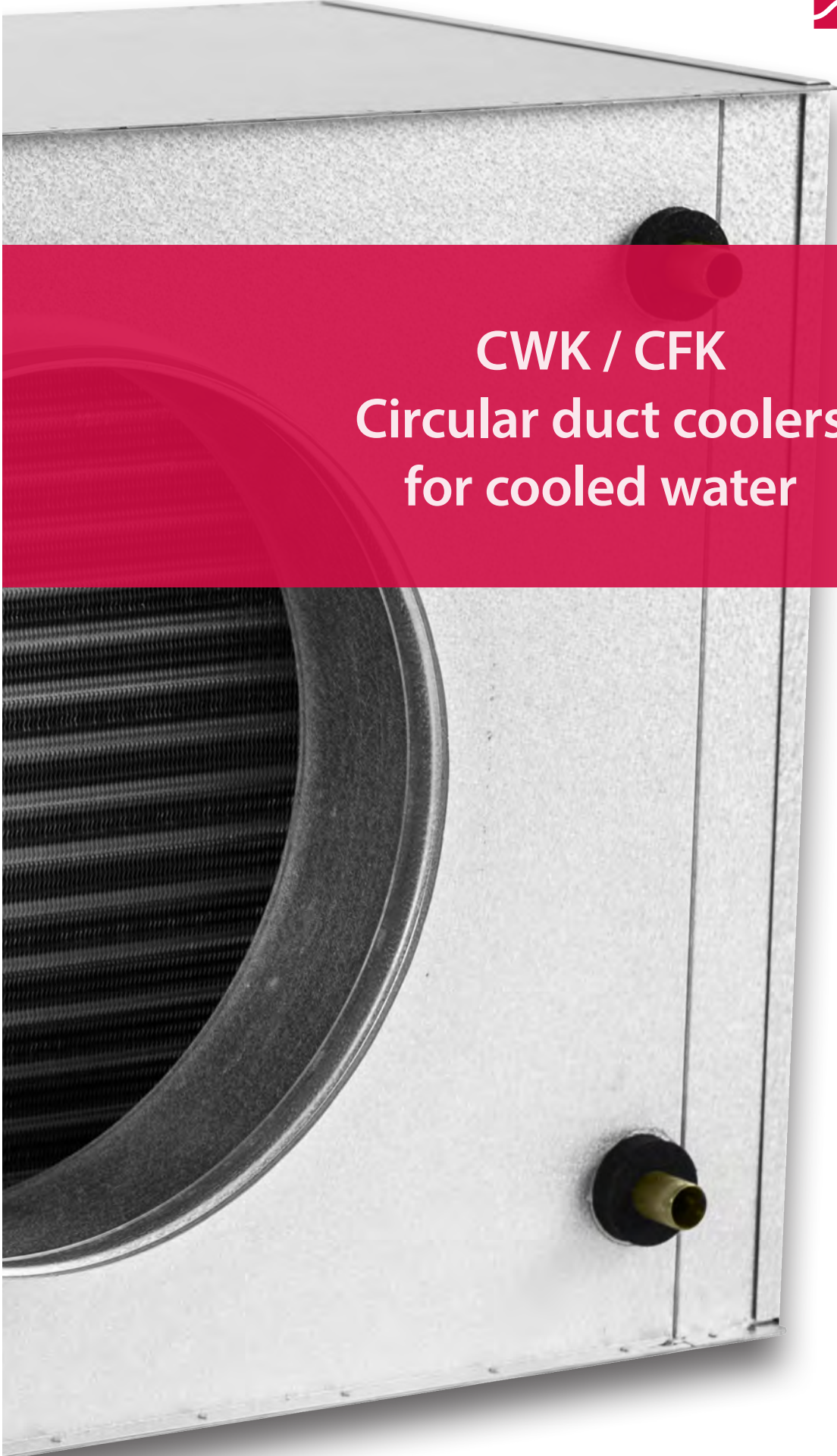

CWK / CFK
Circular duct coolers
for cooled water

CWK

Circular duct coolers for cooled water

CWK duct coolers with circular duct connection use cold water as energy medium and are used to cool the ventilation air in a ventilation system. CWK duct coolers can also be used for individual cooling of specific rooms or areas. To regulate the room or inlet air temperature, the duct coolers are complemented with regulators, sensors, actuators, valves and a frost-protection control.

- 7 standard sizes in stock
- Opening access panel for inspection and cleaning
- Stainless steel drip tray for condensation water
- Air tightness class C as per EN 15727

Design

Casing made of aluzinc-coated sheet steel, AZ 185.
Coil with copper pipes and pipe connections as well as aluminium fins.
Opening access panel for easy inspection and cleaning.
Stainless steel drip tray (EN 1.4301) for condensation water with connection for drain (G $\frac{1}{2}$ ").
Duct connections are fitted with rubber gaskets.

Operating Data

Max. operating temperature: +150 °C
Max. operating pressure: 1.0 MPa (10 bar)
The coils have been pressurised and leak tested.

Dimensioning

Dimensioning can easily be achieved with our web-based calculation program VEAB Select (www.veab.com).
If necessary, contact our sales staff for help.

Installation

CWK are intended for installation in a horizontal duct.

Control Unit

See pages 6 to 8 for a list of regulators, sensors, valves and actuators.

Hygiene

The design with an opening access panel allows for inspection and cleaning of coil, drip tray and air channels. This contributes to cleaner air channels and thus fresh and healthy ventilation air.

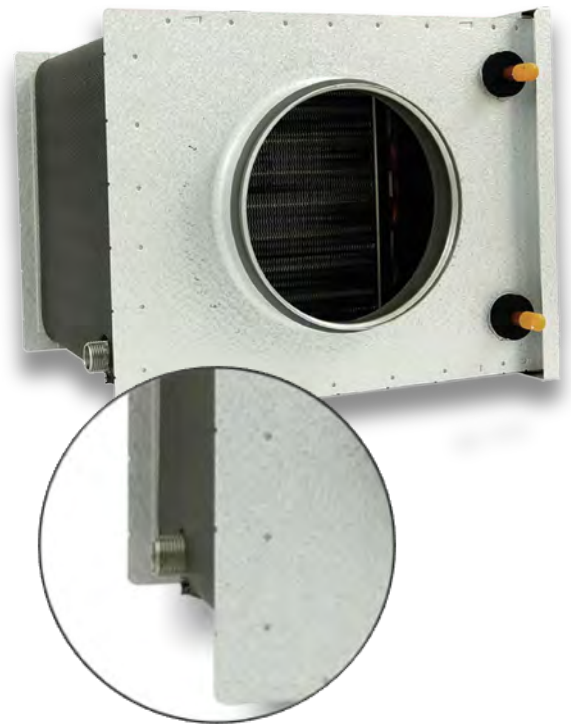

Air Tightness Class C

CWK duct coolers meet air tightness class C as per EN 15727, which ensures that the chilled air reaches its destination and does not leak out of the ventilation system—that saves both energy and money.



Product Range Overview with Dimensional Drawing

Type	∅ D mm	B mm	H mm	∅ dy mm	F mm	G mm	K mm	L mm	Inner pipe volume l	Weight kg
CWK 100-3-2.5	100	251	180	10	100	30	280	340	0.15	4
CWK 125-3-2.5	125	326	255	10	175	35	280	350	0.4	6
CWK 160-3-2.5	160	326	255	10	175	40	280	360	0.4	6
CWK 200-3-2.5	200	411	330	22	250	40	280	360	0.7	9
CWK 250-3-2.5	250	486	405	22	325	40	280	360	1.1	11
CWK 315-3-2.5	315	560	504	22	400	40	280	360	1.61	15
CWK 400-3-2.5	400	710	529	22	425	55	332	442	2.5	20

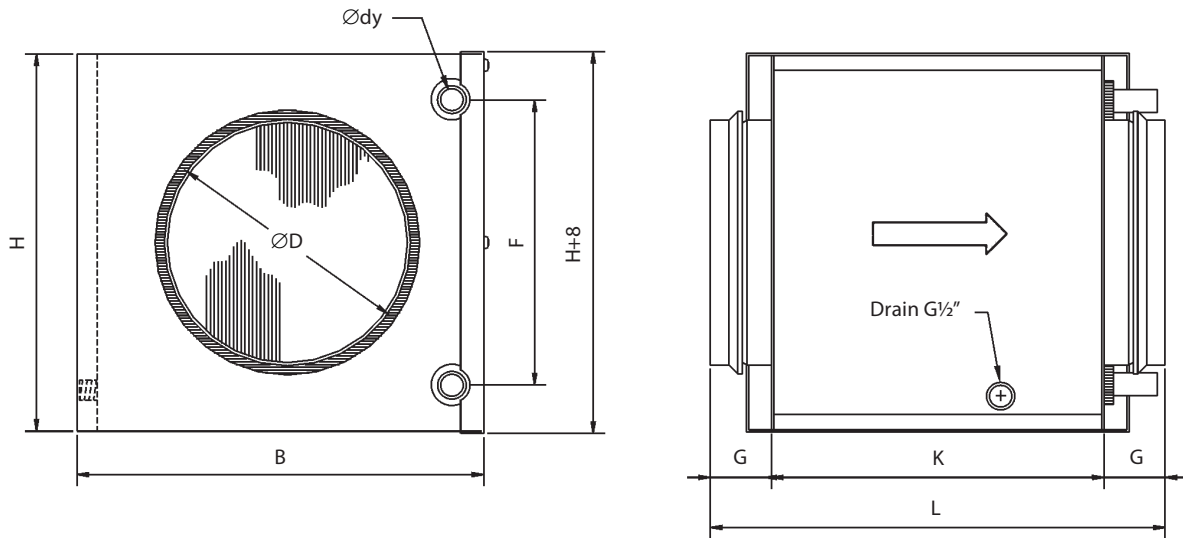

Project Design/Orders

Description – CWK

Duct heater, VEAB type CWK, with casing made of aluzinc-coated sheet steel, AZ 185, coil with copper pipes and pipe connections as well as aluminium fins. Stainless steel drip tray for condensation water. The duct cooler meets air tightness class C. Feedback control is achieved by means of an external regulator, sensors, valves and actuators to be ordered separately.

Type designation CWK 100 - 3 - 2.5

(example)

Size designation

Number of rows of pipes

Fin spacing mm

Specify the following when configuring/ ordering

1. Air flow: - m³/h
2. Inlet air temperature: - °C
3. Outlet air temp. or desired output: - °C or kW
4. Duct dimensions: - mm
5. Inlet water temperature: - °C
6. Outlet water temp. or water flow: - °C or l/s
7. Inlet air humidity: - % RH
8. Antifreeze agent - type / %

CFK

Circular duct coolers for cooled water, Insulated

CFK duct coolers with circular duct connection use cold water as energy medium and are used to cool the ventilation air in a ventilation system. CFK duct coolers can also be used for individual cooling of specific rooms or areas. To regulate the room or inlet air temperature, the duct coolers are complemented with regulators, sensors, actuators and valves.

CFK is supplied with a double-jacket casing and insulated with 50 mm rock wool. The insulation minimises energy loss, and exterior condensation. CFK has an insulated opening access panel making it easy to clean the coil and condensation tray.

Regular cleaning ensures efficiency, and is important for hygiene.

- 6 standard sizes in stock
- Double-jacket casing made of aluzinc-coated sheet steel, AZ 185
- Insulated with 50 mm rock wool
- Opening access panel for inspection and cleaning
- Stainless steel drip tray for condensation water
- Air tightness class C as per EN 15727

Design

Double-jacket casing made of aluzinc-treated steel plate AZ 185 with 50 mm rock wool insulation. Coil with copper pipes and pipe connections as well as aluminium fins.

Stainless steel drip tray (EN 1.4301) for condensation water with connection for drain (G $\frac{1}{2}$ ”).

Duct connections are fitted with rubber gaskets.

Operating Data

Max. operating temperature: +150 °C
 Max. operating pressure: 1.0 MPa (10 bar)
 The coils have been pressurised and leak tested.

Dimensioning

Dimensioning can easily be achieved with our web-based calculation program VEAB Select (www.veab.com).

If necessary, contact our sales staff for help.

Installation

CFK are intended for installation in a horizontal duct.

Control Unit

See pages 6 to 8 for a list of regulators, sensors, valves and actuators.

Hygiene

The design with an opening access panel allows for inspection and cleaning of coil, drip tray and air channels. This contributes to cleaner air channels and thus fresh and healthy ventilation air.



Air Tightness Class C

CFK duct coolers meet air tightness class C as per EN 15727, which ensures that the chilled air reaches its destination and does not leak out of the ventilation system—that saves both energy and money.



Product Range Overview with Dimensional Drawing

Type	∅ D mm	B mm	H mm	∅ dy mm	F mm	G mm	K mm	L mm	Inner pipe volume l	Weight kg
CFK 125-3-2.5	125	404	328	10	175	35	366	436	0.4	10.8
CFK 160-3-2.5	160	404	328	10	175	40	368	448	0.4	10.8
CFK 200-3-2.5	200	489	403	22	250	40	368	448	0.7	15.8
CFK 250-3-2.5	250	564	478	22	325	40	380	460	1.1	20.9
CFK 315-3-2.5	315	639	553	22	400	40	382	462	1.6	28.1
CFK 400-3-2.5	400	789	581	22	425	55	380	490	2.5	38

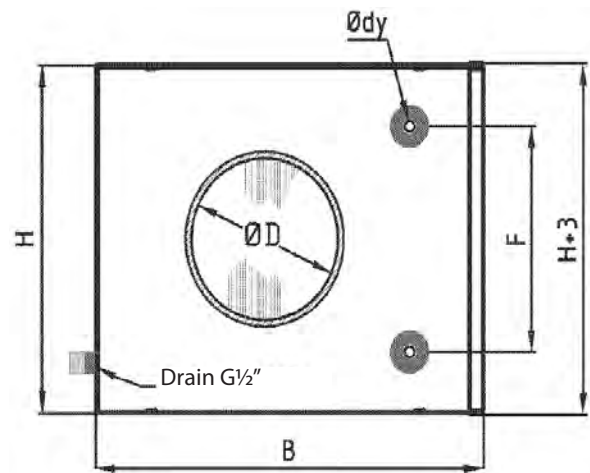
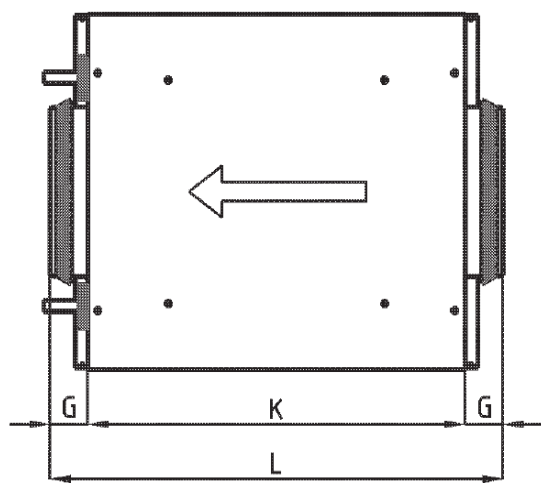

Project Design/Orders

Description – CFK

Duct cooler, VEAB type CFK, with double-jacket casing made of aluzinc-coated sheet steel, AZ 185, insulated with 50 mm rock wool, coil with copper pipes and pipe connections as well as aluminium fins. Stainless steel drip tray for condensation water.

The duct cooler meets air tightness class C. Feedback control is achieved by means of an external regulator, sensors, valves and actuators to be ordered separately.

Type designation **CFK 125 - 3 - 2.5**

(example)

Size designation

Number of rows of pipes

Fin spacing mm

Specify the following when configuring/ ordering

1. Air flow: - m³/h
2. Inlet air temperature: - °C
3. Outlet air temp. or desired output: - °C or kW
4. Duct dimensions: - mm
5. Inlet water temperature: - °C
6. Outlet water temp. or water flow: - °C or l/s
7. Inlet air humidity: - % RH
8. Antifreeze agent - type / %

Regulators



AQUA24TF



RC



RC-DO



OPTIGO OP10

AQUA

Complete regulator with integrated room sensor. Floating feedback control for control of three-position actuators. Cascade connection with minimum limitation of inlet air in case of room feedback control. Can be fitted with external room and/or duct sensor as well as external setpoint adjuster. Temperature range 0-30 °C, depending on choice of sensor.

AQUA24TF

24 V supply. The regulator includes an integrated regulating antifreeze device with two alarm relays and automation for standstill heater.

REGIO MINI

Complete regulator with integrated room sensor. Can be fitted with external room and/or duct sensor. Includes two control outputs for sequential heating and cooling, for example.

RC

24 V supply. 0...10 V outgoing control signal. Base setpoint 20-26 °C is adjusted with DIP switches. The base setpoint can be adjusted by ± 3 °C using the setpoint knob.

RC-DO

24 V supply. 0...10 V outgoing control signal. RC-DO includes a backlighted display and temperature range from 0-50 °C.

OPTIGO

Regulator with display. One knob for all adjustments. To be mounted on DIN rail. Operates with PT1000 sensor within the -20 °C to +40 °C range. Started/stopped with "run" signal from fan.

OP5

24 V supply. 0...10 V outgoing control signal. Operates with a room or duct sensor. Convertible for heating or cooling feedback control.





OP10

24 V supply. Adjustable for 0...10 V outgoing control signal or 3-point feedback control. Two control outputs for sequential heating and cooling, for example. Input for two sensors and possible antifreeze sensor. Inlet air feedback control or room feedback control with cascade controlled inlet air. Antifreeze control with standstill heater. Output for starting/stopping fans, for example, via relay 230 VAC 1-ph., 5 A. Programmable weekly timer for control of both fans and heating/cooling. Outputs for external timer that extends operating time. Can be equipped with an external setpoint adjuster.





OP10-230

Same functions as OP10 but with 230 VAC 1-ph supply.

AQUA Accessories

	Product	Range	Design
	Duct sensor TG-K330	0-30 °C	IP20 degree of protection
	Room sensor TG-R430 With setpoint adjuster	0-30 °C	IP30 degree of protection
	Room sensor TG-R530	0-30 °C	IP30 degree of protection
	Room sensor TG-R630	0-30 °C	IP54 degree of protection
	Transformer 60 Enclosed transformer for wall mounting. Integrated two-pole protection on secondary side.		Input voltage 230 VAC 1-ph. Output voltage 24 VAC 1-ph. Maximum load 60 VA IP44 degree of protection

OPTIGO and REGIO Accessories

	Product	Range	Design
	Duct sensor TG-K3/PT1000	-30...+70 °C	IP20 degree of protection
	Room sensor TG-R5/PT1000	0-50 °C	IP30 degree of protection
	Room sensor TG-UH/PT1000	-30...+120 °C	IP65 degree of protection
	Transformer 60 Enclosed transformer for wall mounting. Integrated two-pole protection on secondary side.		Input voltage 230 VAC 1-ph. Output voltage 24 VAC 1-ph. Maximum load 60 VA IP44 degree of protection

Actuators and Valves with Kvs 0.25 – 8.0 (110 °C max.)

Designation	Type
3-way actuator for ZTV/ZTR valves, IP44 degree of protection	RVAZ4-24
0...10 V actuators for ZTV/ZTR valves, IP44 degree of protection	RVAZ4-24A

Designation	Kvs	Type
2-way valve ½"	0.25	ZTV15-0,25
2-way valve ½"	0.4	ZTV15-0,4
2-way valve ½"	0.6	ZTV15-0,6
2-way valve ½"	1.0	ZTV15-1,0
2-way valve ½"	1.6	ZTV15-1,6
2-way valve ¾"	2.0	ZTV20-2,0
2-way valve ¾"	2.5	ZTV20-2,5
2-way valve ¾"	4.0	ZTV20-4,0
2-way valve ¾"	6.0	ZTV20-6,0
2-way valve 1"	8.0	ZTVB25-8
3-way valve ½"	0.25	ZTR15-0,25
3-way valve ½"	0.4	ZTR15-0,4
3-way valve ½"	0.6	ZTR15-0,6
3-way valve ½"	1.0	ZTR15-1,0
3-way valve ½"	1.6	ZTR15-1,6
3-way valve ¾"	2.0	ZTR20-2,0
3-way valve ¾"	2.5	ZTR20-2,5
3-way valve ¾"	4.0	ZTR20-4,0
3-way valve ¾"	6.0	ZTR20-6,0
3-way valve 1"	8.0	ZTRB25-8

RVAZ4-24 actuator



ZTV valve



ZTR valve



Valve and Actuator Selection Guide for CWK / CFK

Water temp. 110 °C max.

Actuators RVAZ4-24 (3-position) or RVAZ4-24A (0...10 V) can be used for all ZTV/ZTR valves.

Type of CWK / CFK	Valve type	Kvs
CWK 100-3-2.5	2-way ZTV15-0.4	0.4
CWK 125-3-2.5 CFK 125-3-2.5	2-way ZTV15-0.4	0.4
CWK 160-3-2.5 CFK 160-3-2.5	2-way ZTV15-0.4	0.4
CWK 200-3-2.5 CFK 200-3-2.5	2-way ZTV15-0.6	0.6
CWK 250-3-2.5 CFK 250-3-2.5	2-way ZTV15-1.0	1.0
CWK 315-3-2.5 CFK 315-3-2.5	2-way ZTV15-1.6	1.6
CWK 400-3-2.5 CFK 400-3-2.5	2-way ZTV20-2.5	2.5

Pressure Drop Chart for Valves

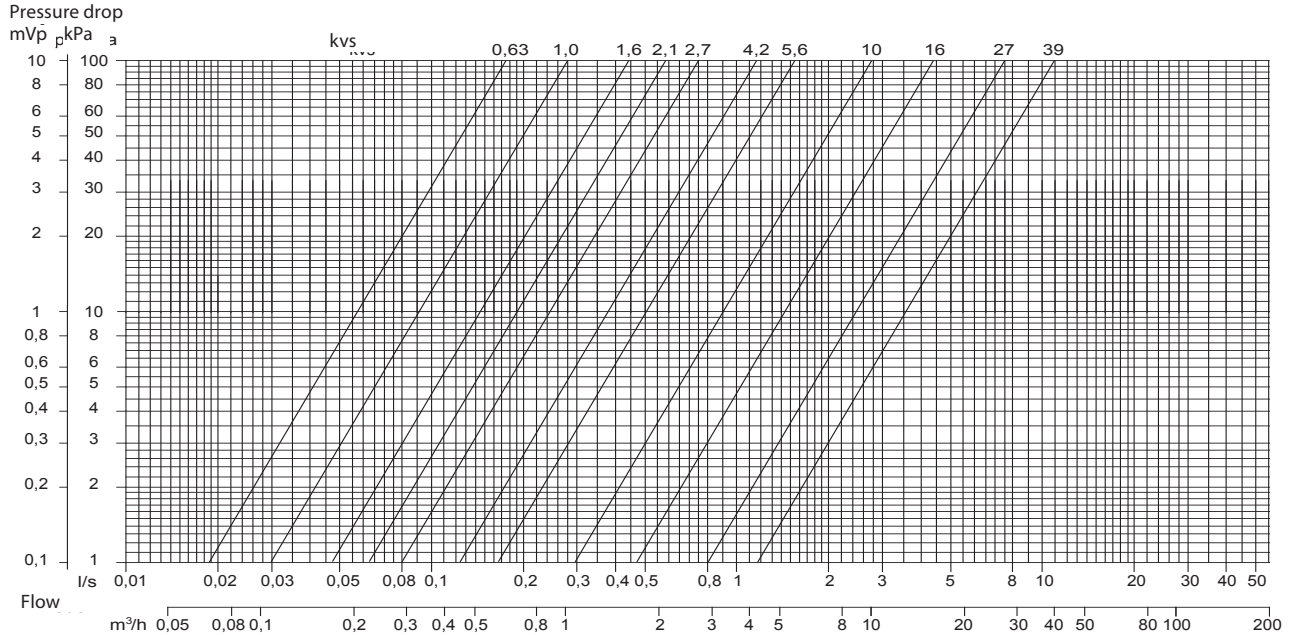



VEAB Heat Tech AB
Tel +46(0)451-485 00
www.veab.com • veab@veab.com
Sweden



PGK
Rectangular duct coolers
for cooled water

PGK

Rectangular duct coolers for cooled water

PGK duct coolers with rectangular duct connection use cold water as energy medium and are used to cool the ventilation air in a ventilation system. PGK duct coolers can also be used for individual cooling of specific rooms or areas.

To regulate the room or inlet air temperature, the duct coolers are complemented with regulators, sensors, actuators and valves.

- 22 standard sizes in stock
- Same model for left or right mounting
- Stainless steel drip tray for condensation water
- Droplet eliminator can be installed regardless of air direction
- Nipples for venting and draining
- Drip tray is easy to remove for cleaning and inspection
- Fins with hydrophilic coating for improved water runoff
- Coil is easy to access for cleaning via the removable drip tray

Design

Casing made of aluzinc-coated sheet steel, AZ 185. Coil with copper pipes and aluminium fins with hydrophilic coating. Nipples for venting and draining. Stainless steel drip tray (EN 1.4301) for collection of condensation water with G $\frac{1}{2}$ " connection for drain.

Operating Data

Max. operating pressure: 1.0 MPa (10 bar)
The coils have been pressurised and leak tested.

Dimensioning

Dimensioning can easily be achieved with our web-based calculation program VEAB Select (www.veab.com). If necessary, contact our sales staff for help.

Installation

PGK duct coolers are intended for installation in horizontal ducts with the air flow in any direction.

Control Unit

See pages 4 to 7 for a list of regulators, sensors, valves and actuators.

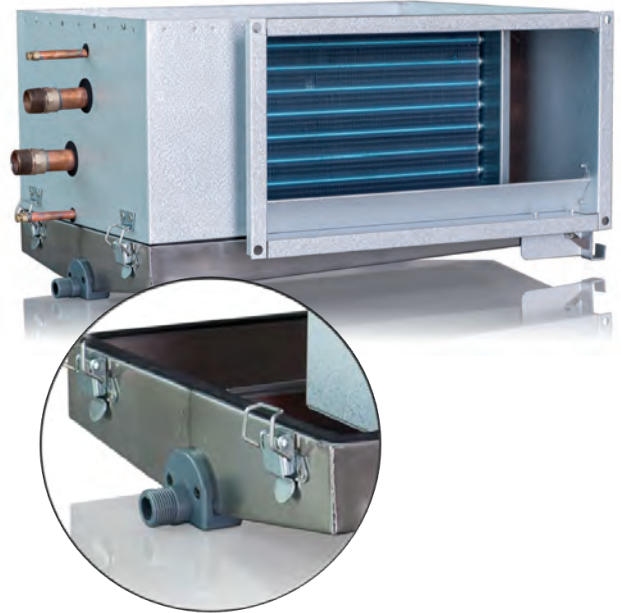

Hygiene

The design, which facilitates cleaning and prevents water accumulation, contributes to ensuring that dirt and stagnant water cannot give rise to bacteria in the ventilation air. In this way, healthy and fresh air is assured.

Droplet Eliminator, DE

For air velocities above 2.5 m/s, we recommend installing a droplet eliminator at the outlet end of the coil. This prevents water droplets from being carried along with the air flowing through the duct system. The accumulated water is drained off via the stainless steel drip tray for condensation water. The droplet eliminator is easy to access after having removed the drip tray. The droplet eliminator must be ordered separately.

Pressure Drop above Droplet Eliminator

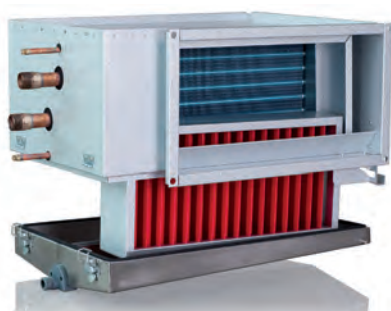
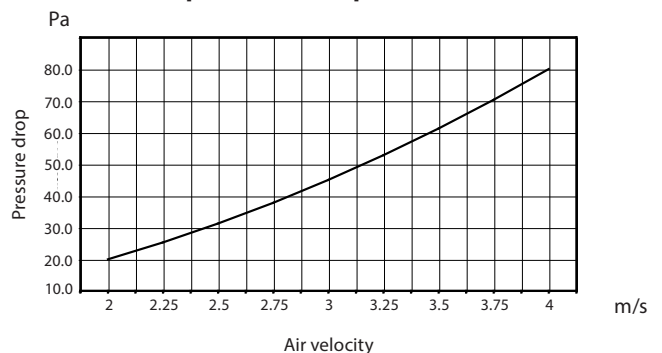

PGK with droplet eliminator DE installed

Product Range Overview with Dimensional Drawing

Type	B mm	H mm	I mm	K mm	M mm	N conn. R	Inner pipe volume l	DE
PGK 250x150-4-2.0	288	188	70	165	65	3/4"	0.63	DE 25x15
PGK 400x200-3-2.0	438	238	70	176	43	3/4"	0.65	DE 40x20
PGK 400x200-4-2.0	438	238	70	176	43	3/4"	0.87	DE 40x20
PGK 500x250-3-2.0	538	288	120	176	43	3/4"	1.02	DE 50x25
PGK 500x250-4-2.0	538	288	120	176	43	3/4"	1.36	DE 50x25
PGK 500x300-3-2.0	538	338	175	176	43	3/4"	1.23	DE 50x30
PGK 500x300-4-2.0	538	338	175	176	43	3/4"	1.64	DE 50x30
PGK 500x400-3-2.0	538	438	270	176	43	3/4"	2.2	DE 50x40
PGK 500x400-4-2.0	538	438	270	176	43	3/4"	3.0	DE 50x40
PGK 600x300-3-2.0	638	338	170	176	43	3/4"	1.47	DE 60x30
PGK 600x300-4-2.0	638	338	170	176	43	3/4"	1.96	DE 60x30
PGK 600x350-3-2.0	638	388	220	176	43	3/4"	1.72	DE 60x35
PGK 600x350-4-2.0	638	388	220	176	43	1"	2.29	DE 60x35
PGK 700x400-3-2.0	738	438	250	170	55	1"	3.09	DE 70x40
PGK 700x400-4-2.0	738	438	250	170	55	1"	4.12	DE 70x40
PGK 800x400-3-2.0	838	438	251	170	55	1"	3.9	DE 80x40
PGK 800x400-4-2.0	838	438	251	170	55	1"	5.1	DE 80x40
PGK 800x500-3-2.0	838	538	340	170	55	1"	4.42	DE 80x50
PGK 800x500-4-2.0	838	538	340	170	55	1 1/4"	5.89	DE 80x50
PGK 1000x500-3-2.0	1038	538	350	170	55	1"	5.52	DE 100x50
PGK 1000x500-4-2.0	1038	538	350	170	55	1 1/4"	7.36	DE 100x50
PGK 1200x600-3-2,0	1238	638	450	170	44	1 1/2"	6,4	DE 120x60

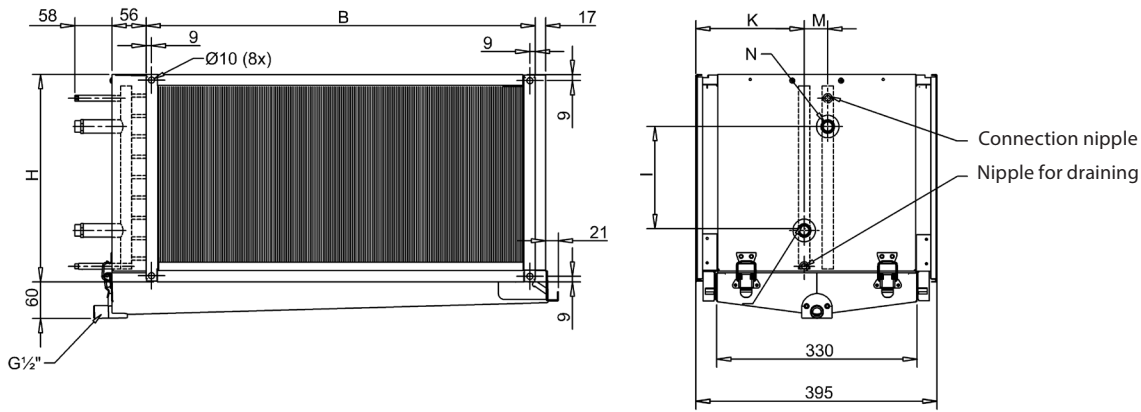

Project Design/Orders

Description – PGK

Duct cooler, VEAB type PGK, with casing made of aluzinc-coated sheet steel, AZ 185, coil with copper pipes and aluminium fins with hydrophilic coating. Stainless steel drip tray for condensation water. Feedback control is achieved by means of an external regulator, sensors, valves and actuators to be ordered separately. For air velocities above 2.5 m/s, order droplet eliminator, DE.

Type designation PGK 400x200 - 3 - 2.0
(example)

Size designation

Number of rows of pipes

Fin spacing mm

Specify the following when configuring/ ordering

- Duct dimensions: - mm
- Air flow: - m³/h
- Inlet air temperature: - °C
- Inlet air humidity: - % RH
- Outlet air temp. or desired output: - °C or kW
- Inlet water temperature: - °C
- Outlet water temp. water flow: - °C or l/s
- Antifreeze agent - type / %
- Possible droplet eliminator

Regulators



AQUA24TF



RC



RC-DO



OPTIGO OP10

AQUA

Complete regulator with integrated room sensor. Floating feedback control for control of three-position actuators. Cascade connection with minimum limitation of inlet air in case of room feedback control. Can be fitted with external room and/or duct sensor as well as external setpoint adjuster. Temperature range 0-30 °C, depending on choice of sensor.

AQUA24TF

24 V supply. The regulator includes an integrated regulating antifreeze device with two alarm relays and automation for standstill heater.

REGIO MINI

Complete regulator with integrated room sensor. Can be fitted with external room and/or duct sensor. Includes two control outputs for sequential heating and cooling, for example.

RC

24 V supply. 0...10 V outgoing control signal. Base setpoint 20-26 °C is adjusted with DIP switches. The base setpoint can be adjusted by ± 3 °C using the setpoint knob.

RC-DO

24 V supply. 0...10 V outgoing control signal. RC-DO includes a backlighted display and temperature range from 0-50 °C.

OPTIGO

Regulator with display. One knob for all adjustments. To be mounted on DIN rail. Operates with PT1000 sensor within the -20 °C to +40 °C range. Started/stopped with "run" signal from fan.

OP5

24 V supply. 0...10 V outgoing control signal. Operates with a room or duct sensor. Convertible for heating or cooling feedback control.





OP10

24 V supply. Adjustable for 0...10 V outgoing control signal or 3-point feedback control. Two control outputs for sequential heating and cooling, for example. Input for two sensors and possible antifreeze sensor. Inlet air feedback control or room feedback control with cascade controlled inlet air. Antifreeze control with standstill heater. Output for starting/stopping fans, for example, via relay 230 VAC 1-ph., 5 A. Programmable weekly timer for control of both fans and heating/cooling. Outputs for external timer that extends operating time. Can be equipped with an external setpoint adjuster.





OP10-230

Same functions as OP10 but with 230 VAC 1-ph supply.

AQUA Accessories

	Product	Range	Design
	Duct sensor TG-K330	0-30 °C	IP20 degree of protection
	Room sensor TG-R430 With setpoint adjuster	0-30 °C	IP30 degree of protection
	Room sensor TG-R530	0-30 °C	IP30 degree of protection
	Room sensor TG-R630	0-30 °C	IP54 degree of protection
	Transformer 60 Enclosed transformer for wall mounting. Integrated two-pole protection on secondary side.		Input voltage 230 VAC 1-ph. Output voltage 24 VAC 1-ph. Maximum load 60 VA IP44 degree of protection

OPTIGO and REGIO Accessories

	Product	Range	Design
	Duct sensor TG-K3/PT1000	-30...+70 °C	IP20 degree of protection
	Room sensor TG-R5/PT1000	0-50°C	IP30 degree of protection
	Room sensor TG-UH/PT1000	-30...+120 °C	IP65 degree of protection
	Transformer 60 Enclosed transformer for wall mounting. Integrated two-pole protection on secondary side.		Input voltage 230 VAC 1-ph. Output voltage 24 VAC 1-ph. Maximum load 60 VA IP44 degree of protection

Actuators and Valves with Kvs 0.25 – 8.0 (110 °C max.)

Designation	Type
3-way actuator for ZTV/ZTR valves, IP44 degree of protection	RVAZ4-24
0...10 V actuators for ZTV/ZTR valves, IP44 degree of protection	RVAZ4-24A

Designation	Kvs	Type
2-way valve 1/2"	0.25	ZTV15-0,25
2-way valve 1/2"	0.4	ZTV15-0,4
2-way valve 1/2"	0.6	ZTV15-0,6
2-way valve 1/2"	1.0	ZTV15-1,0
2-way valve 1/2"	1.6	ZTV15-1,6
2-way valve 3/4"	2.0	ZTV20-2,0
2-way valve 3/4"	2.5	ZTV20-2,5
2-way valve 3/4"	4.0	ZTV20-4,0
2-way valve 3/4"	6.0	ZTV20-6,0
2-way valve 1"	8.0	ZTVB25-8
3-way valve 1/2"	0.25	ZTR15-0,25
3-way valve 1/2"	0.4	ZTR15-0,4
3-way valve 1/2"	0.6	ZTR15-0,6
3-way valve 1/2"	1.0	ZTR15-1,0
3-way valve 1/2"	1.6	ZTR15-1,6
3-way valve 3/4"	2.0	ZTR20-2,0
3-way valve 3/4"	2.5	ZTR20-2,5
3-way valve 3/4"	4.0	ZTR20-4,0
3-way valve 3/4"	6.0	ZTR20-6,0
3-way valve 1"	8.0	ZTRB25-8



RVAZ4-24 actuator



ZTV valve



ZTR valve

Valve and Actuator Selection Guide for PGK

Water temp. 110 °C max.

Actuators RVAZ4-24 (3-position) or RVAZ4-24A (0...10 V) can be used for all ZTV/ZTR valves.

Type of PGK	Valve type	Kvs
PGK 250×150-4-2.0	2-way ZTV15-1.0	1.0
PGK 400×200-3-2.0	2-way ZTV15-1.6	1.6
PGK 400×200-4-2.0	2-way ZTV205-2,0	2.0
PGK 500×250-3-2.0	2-way ZTV15-1.6	1.6
PGK 500×250-4-2.0	2-way ZTV20 -2.0	2.0
PGK 500×300-3-2.0	2-way ZTV20 -2.5	2.5
PGK 500×300-4-2.0	2-way ZTV20 -2.5	2.5
PGK 500×400-3-2.0	2-way ZTV20 -4.0	4.0
PGK 500×400-4-2.0	2-way ZTV20 -4.0	4.0
PGK 600×300-3-2.0	2-way ZTV20 -2.5	2.5
PGK 600×300-4-2.0	2-way ZTV20 -2.5	2.5
PGK 600×350-3-2.0	2-way ZTV20 -2.5	2.5
PGK 600×350-4-2.0	2-way ZTV20 -4.0	4.0
PGK 700×400-3-2.0	2-way ZTV20 -4.0	4.0
PGK 700×400-4-2.0	2-way ZTV20 -4.0	4.0
PGK 800×400-3-2.0	2-way ZTV20 -6.0	6.0
PGK 800×400-4-2.0	2-way ZTV20 -6.0	6.0
PGK 800×500-3-2.0	2-way ZTV20 -6.0	6.0
PGK 800×500-4-2.0	2-way ZTVB25-8	8.0
PGK 1000×500-3-2.0	2-way ZTV20 -6.0	6.0
PGK 1000×500-4-2.0	2-way ZTVB25-8	8.0

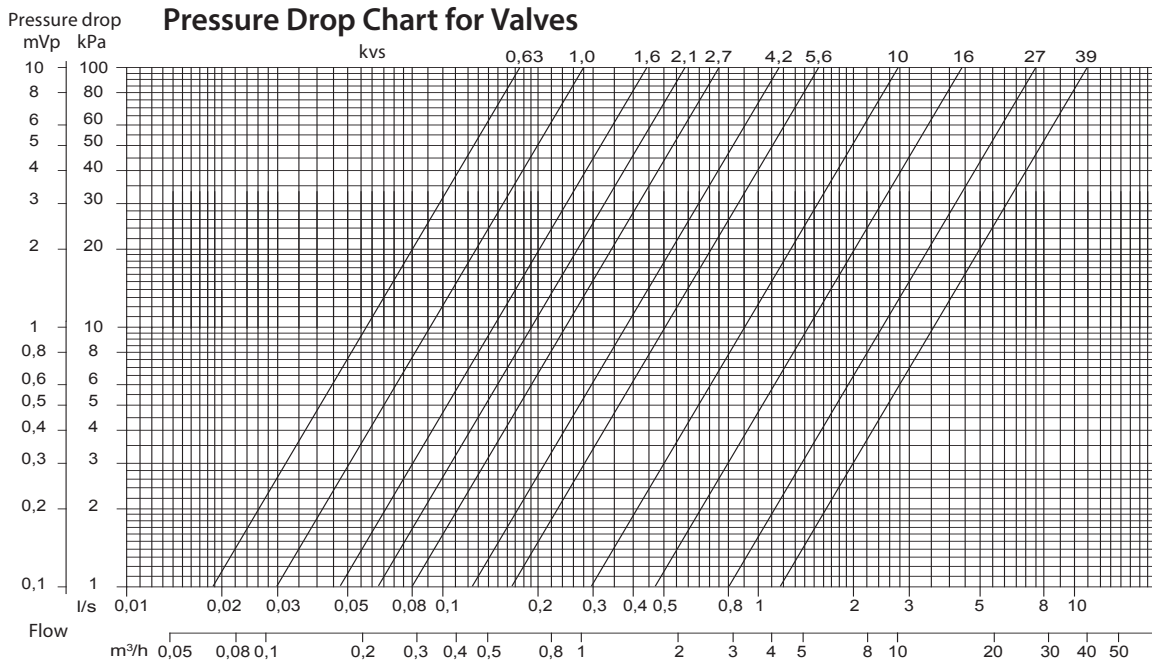



VEAB Heat Tech AB
Tel +46(0)451-485 00
www.veab.com • veab@veab.com
Sweden

PGDX

Rectangular duct cooler for DX cooling
also suitable for cooling and heating
operation together with a heat pump



PGDX

Rectangular duct cooler for DX cooling, also suitable for cooling and heating operation using a heat pump with controller

PGDX duct coolers are used for centralised cooling of the ventilation air in a ventilation system. PGDX duct coolers can also be used in conjunction with a heat pump with controller, which switches between heating and cooling (winter/summer).

- 11 standard sizes in stock
- Same model for left or right mounting
- Stainless steel drip tray for condensation water
- Droplet eliminator can be installed regardless of air direction
- Drip tray is easy to remove for cleaning and inspection
- Fins with hydrophilic coating for improved water runoff
- Coil is easy to access for cleaning via the removable drip tray
- Designed for combined cooling and heating operation using a heat pump with controller

Design

Casing made of aluzinc-coated sheet steel, AZ 185.
Coil with copper pipes and aluminium fins with hydrophilic coating. Stainless steel drip tray for collection of condensation water with G $\frac{1}{2}$ " connection for drain.
Removable drip tray for inspection and cleaning of battery.

Operating Data

Max. operating pressure: 4.29 MPa (42.9 bar)
Test pressure: 4.8 MPa (48 bar)
The batteries have been pressurised and leak tested.

Dimensioning

Dimensioning can easily be achieved with our web-based calculation program VEAB Select (www.veab.com).
If necessary, contact our sales staff for help.

Installation

PGDX duct coolers are intended for installation in horizontal ducts with the air flow in any direction. Supplied pressurised at 2 bar.

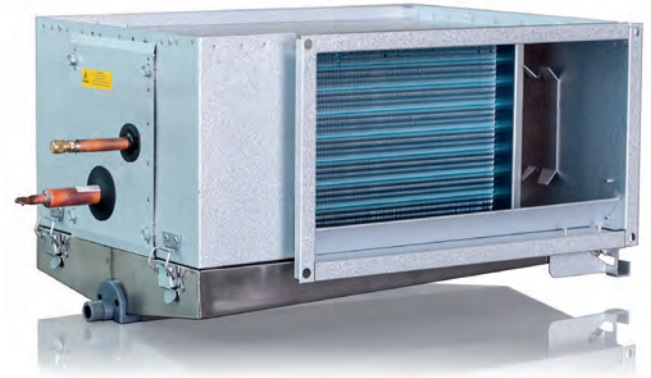

Hygiene

The design, which facilitates cleaning and prevents water accumulation, contributes to ensuring that dirt and stagnant water cannot give rise to bacteria in the ventilation air. In this way, healthy and fresh air is assured.

Droplet Eliminator, DE

For air velocities above 2.5 m/s, we recommend installing a droplet eliminator at the outlet end of the coil. This prevents water droplets from being carried along with the air flowing through the duct system. The accumulated water is drained off via the stainless steel drip tray for condensation water. The droplet eliminator is easy to access after having removed the drip tray.

The droplet eliminator must be ordered separately.

Pressure Drop above Droplet Eliminator

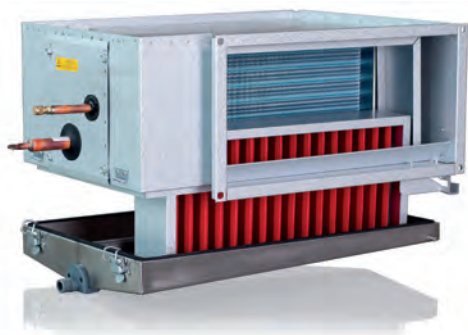
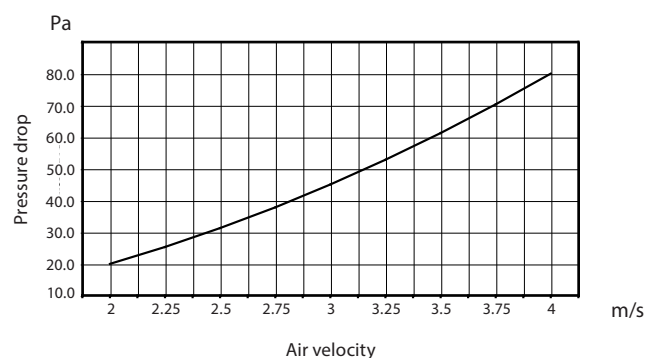

PGDX with droplet eliminator DE installed

Product Range Overview with Dimensional Drawing

Type	B mm	H mm	S mm	R mm	l mm	O mm	K mm	M mm	N Ø	C Ø	Inner pipe volume, l	DE
PGDX 400x200-3-2.5	438	238	56	70	50	200	165		1/2"	3/8"	0.8	DE 40x20
PGDX 500x250-3-2.5	538	288	56	70	40	85	165	67	1/2"	3/8"	1.2	DE 50x25
PGDX 500x300-3-2.5	538	338	56	70	40	85	165	67	5/8"	3/8"	1.4	DE 50x30
PGDX 500x400-3-2.5	538	438	56	70	40	85	165	67	5/8"	3/8"	1.9	DE 50x40
PGDX 600x300-3-2.5	638	338	56	70	40	85	165	67	5/8"	3/8"	1.7	DE 60x30
PGDX 600x350-3-2.5	638	388	56	70	40	85	165	67	5/8"	3/8"	1.9	DE 60x35
PGDX 700x400-3-2.5	738	438	56	70	40	85	165	67	5/8"	3/8"	2.5	DE 70x40
PGDX 800x400-3-2.5	838	438	56	70	40	85	165	67	5/8"	3/8"	2.8	DE 80x40
PGDX 800x500-3-2.5	838	538	86	70	40	85	165	67	7/8"	3/8"	3.6	DE 80x50
PGDX 1000x500-3-2.5	1038	538	86	70	40	85	165	67	7/8"	1/2"	4.4	DE 100x50
PGDX 1200x600-3-2,5	1238	638	86	70	40	95	165	63	7/8"	1/2"	6,2	DE 120x60

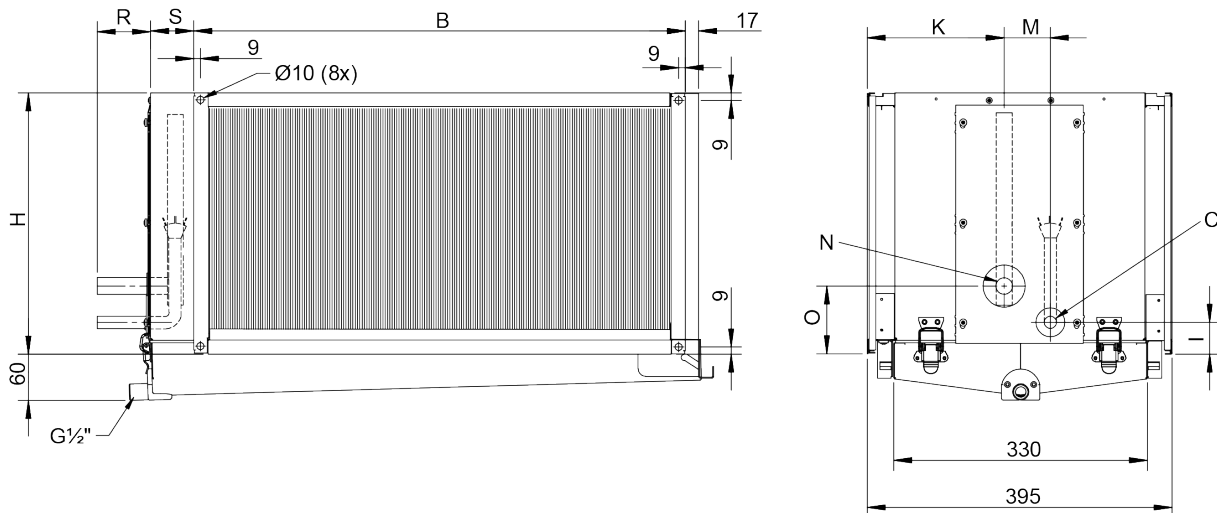

Project Design/Orders

Description – PGDX

Duct cooler, VEAB type PGDX, with casing made of aluzinc-coated sheet steel, AZ 185, coil with copper pipes and aluminium fins with hydrophilic coating. Stainless steel drip tray for condensation water. Designed for combined cooling and heating operation using a heat pump with controller. For air velocities above 2.5 m/s, order droplet eliminator, DE.

Type designation PGDX 400x200 - 3 - 2.5
(example)

Size designation

Number of rows of pipes

Fin spacing mm

Specify the following when configuring/ ordering

1. Air flow: - m³/h
2. Inlet air temperature: - °C
3. Outlet air temp. or desired output: - °C or - kW
4. Duct dimensions: - mm
5. Type of coolant:
6. Evaporation temperature: - °C
7. Inlet air humidity: - % RH
8. Possible droplet eliminator



VEAB Heat Tech AB
Tel +46(0)451-485 00
www.veab.com • veab@veab.com
Sweden



WHS, WCS, SHS, DXES, DXCS and CS
Customized duct heaters,
duct coolers and condensers



WHS / WCS / SHS / DXES / DXCS / CS

Customised rectangular duct heaters, duct coolers and condensers

- Six models for various requirements
- WHS, hot water heater
- WCS, cold water cooler
- SHS, steam heater
- DXES, evaporator for DX cooling
- DXCS, combined battery for DX cooling and heating
- CS, condenser

Design

Refer to respective model as the design varies.

Regulators

See page 9 for a description of the regulators.



DXES



CS



SHS

WHS

Customised rectangular duct heaters for hot water

WHS duct heaters with rectangular duct connection use hot water as energy medium and are used for heating the ventilation air in ventilation systems. The duct heater dimensions and its production are based on the customer's specifications.

- Casing made of hot-dip galvanised sheet steel Magnelis ZM200
- Coil with copper pipes and aluminium fins
- Externally threaded pipe connection
- Screws or guide rail joints are used to connect it to the duct system
- Nipples for venting and draining
- Nipple for installation of antifreeze sensors
- Recommended maximum air velocity: 5 m/s

Design

The casing is made of hot-dip galvanised sheet steel Magnelis ZM200. Coil with copper pipes and aluminium fins.

WHS duct heaters are also equipped with nipples for draining and venting as well as an internally threaded connection for installation of antifreeze sensors.

Drawing and specifications are provided along with the quote.



WHS / WCS / SHS / DXES / DXCS / CS

Other Types of Materials

If required, WHS duct heaters are available in a corrosion resistant execution with a frame made of stainless material and epoxy-coated aluminium fins or with copper fins for use in humid and corrosive environments.

Operating Data

Max. operating temperature: +150 °C
 Max. operating pressure: 1.0 MPa (10 bar)
 The coils have been pressurised and leak tested.

Installation

WHS duct heaters can be installed in horizontal or vertical ducts. Specify air direction when ordering.

Control Unit

VEAB has a complete range of regulators, sensors, actuators and valves for feedback control of room and Inlet air temperature. We also have regulators with integrated antifreeze control, alarm and standstill heater.

Project Design/Orders

Description – WHS

Duct heater, VEAB type WHS, with casing made of hot-dip galvanised sheet steel Magnelis ZM200, coil with copper pipes and aluminium fins. Equipped with nipples for draining and venting as well as an internally threaded connection for antifreeze sensors (dipping sensors). Externally threaded water connections.

Type designation WHS 400x200 - 3 - 2.5
 (example)

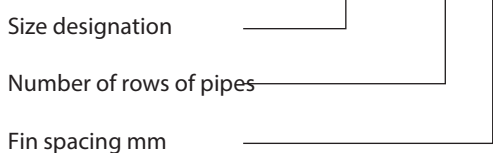

Specify the following when configuring/ ordering

1. Duct dimensions: - mm
2. Air direction: - Left/right
3. Air flow: - m³/h
4. Inlet air temperature: - °C
5. Outlet air temp. or desired output: - °C or kW
6. Inlet water temperature: - °C
7. Outlet water temp. water flow: - °C or l/s
8. Antifreeze agent: - type / %

WCS

Customised rectangular duct coolers for cooled water

WCS duct coolers with rectangular connection use cold water as energy medium and are used to cool the ventilation air in a ventilation system. The duct cooler dimensions and its production are based on the customer's specifications.

- Casing made of hot-dip galvanised sheet steel Magnelis ZM200
- Coil with copper pipes and aluminium fins
- Externally threaded pipe connection
- Screws or guide rail joints are used to connect it to the duct system
- Stainless steel drip tray for condensation water
- Nipples for venting and draining
- Recommended maximum air velocity: 3 m/s

Design

The casing is made of hot-dip galvanised sheet steel Magnelis ZM200. Coil with copper pipes and aluminium fins.

WCS duct coolers also come with nipples for draining and venting.

An internally threaded connection for installation of anti-freeze dipping sensors must be requested as an extra option.

Drawing and specifications are provided along with the quote.

Other Types of Materials

If required, WCS duct coolers are available in a corrosion resistant execution with a frame made of stainless material and epoxy-coated aluminium fins or with copper fins for use in humid and corrosive environments.

Operating Data

Max. operating pressure: 1.0 MPa (10 bar)

The coils have been pressurised and leak tested.



Installation

WCS duct coolers are intended for installation in horizontal ducts. Specify air direction when ordering.

Droplet Eliminator

For air velocities above 2.5 m/s, we recommend installing a droplet eliminator. The droplet eliminator is installed at the outlet end of the battery. This prevents water droplets from being carried along with the air flowing through the duct system. The droplet eliminator must be ordered separately.

Control Unit

VEAB has a complete range of regulators, sensors, actuators and valves for feedback control of room and inlet air temperature.

Project Design/Orders

Description – WCS

Duct cooler, VEAB type WCS, with casing made of hot-dip galvanised sheet steel Magnelis ZM200, coil with copper pipes and aluminium fins. WCS duct coolers come with nipples for draining and venting. Externally threaded water connections. Stainless steel drip tray equipped with externally threaded connection for condensation water. For air velocities above 2.5 m/s, order droplet eliminator, DE.

Type designation WCS 400×200 - 3 - 2.5
(example)

Size designation

Number of rows of pipes

Fin spacing mm

Specify the following when configuring/ ordering

1. Duct dimensions: - mm
2. Air direction: - Left/right
3. Air flow: - m³/h
4. Inlet air temperature: - °C
5. Inlet air humidity: - % RH
6. Outlet air temp.
or desired output: - °C or kW
7. Inlet water temperature: - °C
8. Outlet water temp.
water flow: - °C or l/s
9. Antifreeze agent: - type / %
10. Possible droplet eliminator

SHS

Customised rectangular duct heaters for steam

SHS duct heaters with rectangular duct connection use steam as energy medium and are used for heating the ventilation air in ventilation systems. The duct heater dimensions and its production are based on the customer's specifications.

- Casing made of hot-dip galvanised sheet steel Magnelis ZM200
- Coil with copper pipes and aluminium fins
- Externally threaded pipe connection
- Screws are used to connect it to the duct
- Recommended maximum air velocity: 5 m/s

Design

The casing is made of hot-dip galvanised sheet steel Magnelis ZM200. Coil with copper pipes and aluminium fins. Drawing and specifications are provided along with the quote.

Other Types of Materials

If required, SHS duct heaters are available in a corrosion resistant execution with a frame made of stainless material and epoxy-coated aluminium fins or with copper fins for use in humid and corrosive environments.

Operating Data

Max. operating temperature: +164°C
 Max. operating pressure: 0.6 MPa (6 bar)
 The coils have been pressurised and leak tested.



WHS / WCS / SHS /
DXES / DXCS / CS

Installation

SHS duct heaters are intended for installation in horizontal ducts. Specify air direction when ordering.

Project Design/Orders

Description – SHS

Duct heater, VEAB type SHS, with casing made of hot-dip galvanised sheet steel Magnelis ZM200, coil with copper pipes and aluminium fins. Externally threaded connecting pipe.

Specify the following when configuring/ ordering

- | | |
|--|---------------------|
| 1. Duct dimensions: | - mm |
| 2. Air flow: | - m ³ /h |
| 3. Inlet air temperature: | - °C |
| 4. Outlet air temp. or desired output: | - °C or kW |
| 5. Steam temp.: | - °C |
| 6. Operating pressure | - bar |

Type designation SHS 400×200 - 1 - 2.5

(example)

Size designation

Number of rows of pipes (2 max.)

Fin spacing mm

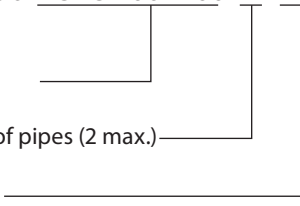

DXES

Customised rectangular duct coolers with DX coil

DXES duct coolers with rectangular duct connection use an evaporating cooling agent as its energy medium and is used for cooling the ventilation air in ventilation systems. The duct cooler is designed and produced based on the customer's specifications.

- Casing made of hot-dip galvanised sheet steel Magnelis ZM200
- Coil with copper pipes and aluminium fins
- The pipe connection is to be soldered
- Screws or guide rail joints are used to connect it to the duct system
- Stainless steel drip tray for condensation water
- Recommended maximum air velocity: 3 m/s

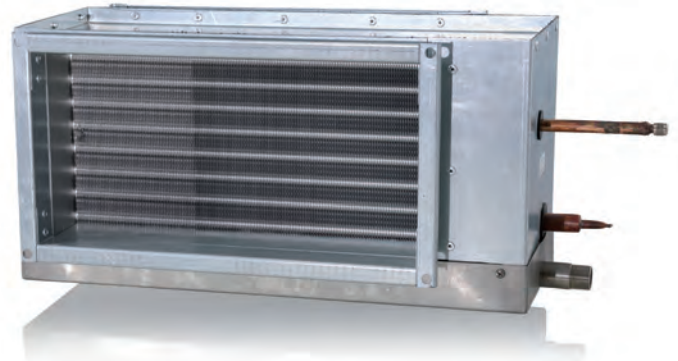

Design

The casing is made of hot-dip galvanised sheet steel Magnelis ZM200. Coil with copper pipes and aluminium fins. Drawing and specifications are provided along with the quote.

Other Types of Materials

If required, DXES duct coolers are available in a corrosion-resistant execution with a frame made of stainless material and epoxy-coated aluminium fins or with copper fins for use in humid and corrosive environments.

Operating Data

Max. operating pressure: 4.17 MPa (41.7 bar)
 Test pressure: 4.8 MPa (48 bar)
 The batteries have been pressurised and leak tested.

Installation

DXES duct coolers are intended for installation in horizontal ducts. Specify air direction when ordering. Supplied pressurised at 2 bar.

Droplet Eliminator

For air velocities above 2.5 m/s, we recommend installing a droplet eliminator at the outlet end of the coil. This prevents water droplets from being carried along with the air flowing through the duct system. The droplet eliminator must be ordered separately.

Project Design/Orders

Description – DXES

Duct cooler, VEAB type DXES for DX cooling, with casing made of hot-dip galvanised sheet steel Magnelis ZM200, coil with copper pipes and aluminium fins. Pipe connections are to be soldered. Stainless steel drip tray equipped with externally threaded connection for condensation water. For air velocities above 2.5m/s, order the DXES with droplet eliminator, DE.

Type designation **DXES 400×200 - 3 - 2.5**

(example)

Size designation

Number of rows of pipes

Fin spacing mm

Specify the following when configuring/ ordering

1. Duct dimensions: - mm
2. Air direction: - Left/right
3. Air flow: - m³/h
4. Inlet air temperature: - °C
5. Inlet air humidity: - % RH
6. Outlet air temp. or desired output: - °C or kW
7. Type of coolant: - °C
8. Evaporation temp.:
9. Possible droplet eliminator
10. Min. and max. inner volume of coil

DXCS

Customised rectangular duct batteries for combined cooling and heating, for heat pump with dual pipe connections and controller

DXCS duct batteries with rectangular connection use a coolant as its energy medium and are used for cooling and heating the ventilation air in ventilation systems. The duct battery is designed and produced based on the customer's specifications.

- Casing made of hot-dip galvanised sheet steel Magnelis ZM200
- Coil with copper pipes and aluminium fins
- The pipe connection is to be soldered
- Screws or guide rail joints are used to connect it to the duct system
- Stainless steel drip tray for condensation water
- Recommended maximum air velocity: 3 m/s

Design

The casing is made of hot-dip galvanised sheet steel Magnelis ZM200. Coil with copper pipes and aluminium fins. Drawing and specifications are provided along with the quote.

Other Types of Materials

If required, DXCS duct batteries are available in a corrosion-resistant execution with a frame made of stainless material and epoxy-coated aluminium fins or with copper fins for use in humid and corrosive environments.

Operating Data

Max. operating pressure: 4.17 MPa (41.7 bar)
 Test pressure: 4.8 MPa (48 bar)
 The batteries have been pressurised and leak tested.

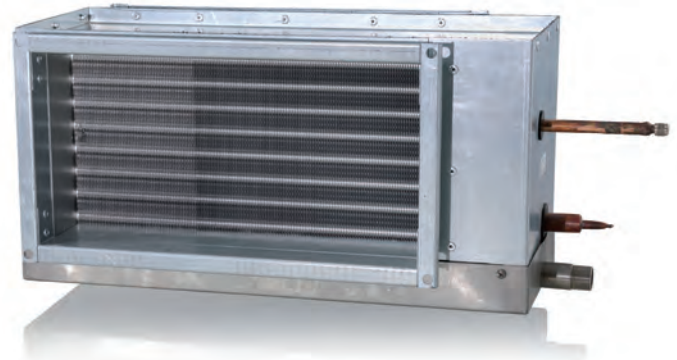

WHS / WCS / SHS / DXES / DXCS / CS

Installation

DXCS duct batteries are intended for installation in horizontal ducts. Specify air direction when ordering. Supplied pressurised at 2 bar.

Droplet Eliminator

For air velocities above 2.5 m/s, we recommend installing a droplet eliminator. The droplet eliminator is installed at the outlet end of the battery. This prevents water droplets from being carried along with the air flowing through the duct system. The droplet eliminator must be ordered separately.

Project Design/Orders

Description – DXCS

Duct battery, VEAB type DXCS for coolant, with casing made of hot-dip galvanised sheet steel Magnelis ZM200, coil with copper pipes and aluminium fins. Pipe connections are to be soldered. Stainless steel drip tray equipped with externally threaded connection for condensation water. For air velocities above 2.5 m/s, order the DXCS with droplet eliminator, DE.

Type designation DXCS 400×200 - 3 - 2.5

(example)

Size designation

Number of rows of pipes

Fin spacing mm

Specify the following when configuring/ ordering

1. Duct dimensions: - mm
2. Air direction: - Left/right
3. Air flow: - m³/h
4. Inlet air temperature: - °C
5. Inlet air humidity: - % RH
6. Outlet air temp. or desired output: - °C or kW
7. Type of coolant:
8. Evaporation temp.: - °C
9. Condensing temperature - °C
10. Possible droplet eliminator
11. Min. and max. inner volume of coil
12. Cooling and heating output on outdoor unit

CS

Customised rectangular condensers for in-duct mounting

CS is a condenser used for condensing a coolant. Condensers are designed and produced based on the customer's specifications.

- Casing made of hot-dip galvanised sheet steel Magnelis ZM200
- Coil with copper pipes and aluminium fins
- The pipe connection is to be soldered
- Screws or guide rail joints are used to connect it to the duct system

Design

The casing is made of hot-dip galvanised sheet steel Magnelis ZM200. The condenser has copper pipes and aluminium fins. Drawing and specifications are provided along with the quote.

Other Types of Materials

If required, CS condensers are available in a corrosion resistant execution with a frame made of stainless material and epoxy-coated aluminium fins or with copper fins for use in humid and corrosive environments.



Operating Data

Max. operating pressure: 4.17 MPa (41.7 bar)
 Test pressure: 4.8 MPa (48 bar)
 The batteries have been pressurised and leak tested.

Installation

CS condensers can be installed in horizontal or vertical ducts. Air direction must be specified in order. Supplied pressurised at 2 bar.

Project Design/Orders

Description – CS

Condenser for duct installation. VEAB type CS, with casing made of hot-dip galvanised sheet steel Magnelis ZM200, coil with copper pipes and aluminium fins. Pipe connections are to be soldered.

Type designation CS 400×200 - 3 - 2.5

(example)

Size designation

Number of rows of pipes

Fin spacing mm

Specify the following when configuring/ordering

1. Duct dimensions: - mm
2. Air direction: - Left/right
3. Air flow: - m³/h
4. Inlet air temperature: - °C
5. Outlet air temp. or desired output: - °C or kW
6. Type of coolant:
7. Condensation temp.: - °C
8. Nominal condenser capacity: - kW
9. Min. and max. inner volume of coil

Regulators for Water Based Systems



AQUA24TF



RC



RC-DO



OPTIGO OP10

AQUA

Complete regulator with integrated room sensor. Floating feedback control for control of three-position actuators. Cascade connection with minimum limitation of inlet air in case of room feedback control. Can be fitted with external room and/or duct sensor as well as external setpoint adjuster. Temperature range 0-30 °C, depending on choice of sensor.

AQUA24TF

24 V supply. The regulator includes an integrated regulating antifreeze device with two alarm relays and automation for standstill heater.

REGIO MINI

Complete regulator with integrated room sensor. Can be fitted with external room and/or duct sensor. Includes two control outputs for sequential heating and cooling, for example.

RC

24 V supply. 0...10 V outgoing control signal. Base setpoint 20-26 °C is adjusted with DIP switches. The base setpoint can be adjusted by ± 3 °C using the setpoint knob.

RC-DO

24 V supply. 0...10 V outgoing control signal. RC-DO includes a backlighted display and temperature range from 0-50 °C.

OPTIGO

Regulator with display. One knob for all adjustments. To be mounted on DIN rail. Operates with PT1000 sensor within the -20 °C to $+40$ °C range. Started/stopped with "run" signal from fan.

OP5

24 V supply. 0...10 V outgoing control signal. Operates with a room or duct sensor. Convertible for heating or cooling feedback control.

OP10

24 V supply. Adjustable for 0...10 V outgoing control signal or 3-point feedback control. Two control outputs for sequential heating and cooling, for example. Input for two sensors and possible antifreeze sensor. Inlet air feedback control or room feedback control with cascade controlled inlet air. Antifreeze control with standstill heater. Output for starting/stopping fans, for example, via relay 230 VAC 1-ph., 5 A. Programmable weekly timer for control of both fans and heating/cooling. Outputs for external timer that extends operating time. Can be equipped with an external setpoint adjuster.

OP10-230

Same functions as OP10 but with 230 VAC 1-ph supply.

Sensors for AQUA

Temperature sensor with NTC elements for use with AQUA regulators:
TG-K330, TG-R430, TG-R530, TG-R630, TG-A130, TG-D130 and TG-D230.

Sensors for OPTIGO and Region MINI

Temperature sensor with PT-1000 elements for use with OPTIGO regulators:
TG-K3, TG-R4, TG-R5, TG-UH, TG-A1, TG-D1 and TG-D2.



VEAB Heat Tech AB
Tel +46(0)451-485 00 • Fax +46(0)451-410 80
www.veab.com • veab@veab.com
Sweden



Nicht abdecken Do not cover Ne pas couvrir Niet afdekken Nie przykrywać

ROBUST

Electric fan heaters for demanding environments



ROBUST

Electric fan heaters for demanding environments

Robust is a range of electric fan heaters that are suitable for environments with stringent safety requirements, such as potentially flammable or corrosive environments.

- 4 models for various harsh environments
- ROBUST F for potentially flammable environments
- ROBUST C for corrosive environments
- Robust H for industrial applications (up to 70 °C ambient temperature)
- ROBUST V for ships and offshore
- All models are suitable for 50 and 60 Hz.



Design

Refer to respective model as the design varies.

Feedback Control

All models include an integrated thermostat and power selector. For control using external accessories, see respective model.



Approvals

Fan heater tested and approved by Intertek Semko AB according to:
 LVD directive: EN 60335-1, EN 60335-2-30, SEMKO 111FF-1987 (Robust F only) and EMKO-TUB(61)N289/90 (Robust F only).
 EMC directives: EN 61000-6-2, EN 61000-6-3 and EN 61000-6-3-11.
 EMF directive: EN 62233

Robust V is additionally approved in accordance with the following:
 DNV; vibration test



ROBUST F

Electric fan heaters for fire hazardous environments

Robust F has been tested and is approved for use in premises that are classified as potentially flammable due to the amount of dust they contain. Examples of application areas include animal barns and woodworking joinery shops.

- Approved for use in potentially flammable areas
- Low heating element temperature prevents dust from igniting
- Casing, heating elements, grille and legs/stand made of stainless steel
- IP65 degree of protection—protected against dust and water jets

Design

The casing is made of stainless sheet steel, EN 1.4016, the heating elements and grille are made of acid-resistant stainless steel, EN 1.4404, and the legs/stand are made of stainless steel, EN 1.4301. Integrated thermostat and power selector.

Easy electrical installation with plug (except 230 VAC 3-ph.).

IP65 degree of protection (protected against dust and water jets).



Product Range Overview

Type		F2	F3	F6	F6N	F9	F9N
Voltage	V	230 VAC 1-ph. 50/60 Hz	230 VAC 1-ph. 50/60 Hz	400 VAC 3-ph. 50/60 Hz	230 VAC 3-ph. 50/60 Hz	400 VAC 3-ph. 50/60 Hz	230 VAC 3-ph. 50/60 Hz
Output	kW	2	3	6	6	9	9
Output stage	kW	0-1-2	0-2-3	0-3-6	0-3-6	0-4.5-9	0-4.5-9
Current	A	4.4 / 8.8	9.1 / 13.5	4.8 / 9.1	8 / 15.5	6.7 / 13.2	11.6 / 22.9
Temp. increase due to heater	°C	14	21	24	24	25	25
Thermostat	°C	0-35	0-35	0-35	0-35	0-35	0-35
Sound pressure level ¹⁾	dB(A)	48	48	53	53	55	55
Air volume	m ³ /h	400	400	700	700	1000	1000
Weight	kg	11	11	13	13	19	19
Width × Height × Depth	mm	300 × 375 × 360	300 × 375 × 360	300 × 375 × 360	300 × 375 × 360	375 × 445 × 432	375 × 445 × 432

¹⁾ Measured at 5 metres in front of appliance.

Project Design/Orders

Description – Robust F

Electrical fan heater, VEAB type Robust F, with casing made of stainless sheet steel, EN 1.4016, heating elements and grille made of acid-resistant stainless steel, EN 1.4404, and legs/stand made of stainless steel, EN 1.4301. IP65 degree of protection. Feedback control is achieved by means of the integrated thermostat and the power selector.

ROBUST C

Electric fan heaters for corrosive environments

Robust C has been specially designed for wall-mounting in corrosive environments, such as vehicle washing facilities, sewage treatment plants and industrial plants. Robust C features an IP65 degree of protection and is thus protected against water projected from a nozzle.

- Approved for use in humid and corrosive environments
- Casing, heating elements, grille and legs/stand made of stainless steel
- All models are for mobile use or wall mounting
- IP65 degree of protection—protected against dust and water jets
- Corrosion class C5-M

Design

The casing, heating elements and grille are made of acid-resistant stainless steel, EN 1.4404 and the legs/stand are made of stainless steel, EN 1.4301. Integrated thermostat and power selector. Easy electrical installation with plug (except 230 VAC 1-ph., 230 VAC 3-ph.). IP65 degree of protection (protected against dust and water jets).

Accessories

An external RTC/RTC4 control box, with IP65 degree of protection can be connected to the Robust C.



Product Range Overview

Type		C3	C6	C6N	C9	C9N	C15
Voltage	V	230 VAC 1-ph. 50/60 Hz	400 VAC 3-ph. 50/60 Hz	230 VAC 3-ph. 50/60 Hz	400 VAC 3-ph. 50/60 Hz	230 VAC 3-ph. 50/60 Hz	400 VAC 3-ph. 50/60 Hz
Output	kW	3	6	6	9	9	15
Output stage	kW	0-2-3	0-3-6	0-3-6	0-4.5-9	0-4.5-9	0-7.5-15
Current	A	9.1 / 13.5	4.5 / 8.9	7.8 / 15.4	6.7 / 13.2	11.6 / 22.9	11.2 / 22
Temp. increase due to heater	°C	21	17	17	25	25	32
Thermostat	°C	0-35	0-35	0-35	0-35	0-35	0-35
Sound pressure level ¹⁾	dB(A)	48	55	55	55	55	62
Air volume	m ³ /h	400	1000	1000	1000	1000	1300
Weight	kg	11	19	19	19	19	22
Width	mm	300	375	375	375	375	375
Height	mm	375	445	445	445	445	445
Depth	mm	360	432	432	432	432	432

¹⁾ Measured at 5 metres in front of appliance.

Project Design/Orders

Description – Robust C

Electrical fan heater, VEAB type Robust C, with casing, heating element and grille made of stainless, acid-resistant steel, EN 1.4404, and legs/stand made of stainless steel, EN 1.4301. IP65 degree of protection. Feedback control is achieved by means of the integrated thermostat and the power selector. Optional RTC/RTC4 external control box to be ordered separately.

ROBUST H

Electric fan heaters for industrial applications

Robust H is intended for applications and premises that need to be heated to a max. temperature of 70 °C. The fans are used for drying and curing processes as well as for pest control.

- Approved for temperatures up to 70 °C
- Casing, heating elements, grille and legs/stand made of stainless steel
- All models are for mobile use or wall mounting
- IP44 degree of protection splash-proof

Design

The casing is made of stainless sheet steel, EN 1.4016, the heating elements and grille are made of acid-resistant stainless steel, EN 1.4404, and the legs/stand are made of stainless steel, EN 1.4301. Integrated thermostat and power selector. Easy electrical installation with plug (except 230 VAC 3-ph.). IP44 degree of protection (splash-proof).

Accessories

An external RTH thermostat, with IP44 degree of protection can be connected to the Robust H.



Product Range Overview

Type		H6	H6N	H9
Voltage	V	400 VAC 3-ph. N 50/60 Hz	230 VAC 3-ph. 50/60 Hz	400 VAC 3-ph. N 50/60 Hz
Output	kW	6	6	9
Output stage	kW	0-3-6	0-3-6	0-4.5-9
Current	A	4.5 / 8.9	7.8 / 15.4	6.7 / 13.2
Temp. increase due to heater	°C	17	17	25
Thermostat	°C	0-70	0-70	0-70
Sound pressure level ¹⁾	dB(A)A	55	55	55
Air volume	m ³ /h	1000	1000	1000
Weight	kg	19	19	19
Width × Height × Depth	mm	375 × 445 × 432	375 × 445 × 432	375 × 445 × 432

¹⁾ Measured at 5 metres in front of appliance.

Project Design/Orders

Description – Robust H

Electrical fan heater, VEAB type Robust H, with casing made of stainless sheet steel, EN 1.4016, heating elements and grille made of acid-resistant stainless steel, EN 1.4404, and legs/stand made of stainless steel, EN 1.4301. IP44 degree of protection. Feedback control is achieved by means of the integrated thermostat and the power selector. Optional RTH thermostat to be ordered separately.

ROBUST V

Electric fan heaters for marine and offshore applications

Robust V is designed for use on ships and in the offshore industry.

The heating elements are electrically insulated from the casing to prevent leakage currents.

- Tested and approved by Det Norske Veritas
- Electrical safety and vibration tested for use on ships
- Reinforced electrical insulation
- Bracketed heating elements and reinforced motor support
- All models are for mobile use or wall mounting
- IP44 degree of protection splash-proof



Design

The casing is made of stainless sheet steel, EN 1.4016, the grille is made of stainless steel, EN 1.4301, and the legs/wall bracket are made of zinc-plated sheet steel lacquered with black epoxy. Robust V3, V3R and V3.6 come with heating elements made of acid-resistant stainless steel, EN 1.4404 and Robust V5, V5N and V6 come with heating elements made of stainless steel, EN 1.4301. The heating elements are electrically insulated from the casing to eliminate leakage currents. Heating element package and motor with reinforced fastenings to handle vibrations on ships. Integrated thermostat and power selector. IP44 degree of protection (splash-proof).



The bracket is designed so that the heater can also be placed on the floor.

Accessories

An external RTC/RTC4 control box, with IP65 degree of protection can be connected to the Robust V.



Product Range Overview

Type		V3R	V3	V3.6	V5N	V5	V6
Voltage	V	230 VAC 1-ph. 50/60 Hz	400 VAC 3-ph. 50/60 Hz	440 VAC 3-ph. 50/60 Hz	230 VAC 3-ph. 50/60 Hz	400 VAC 3-ph. 50/60 Hz	440 VAC 3-ph. 50/60 Hz
Output	kW	3	3	3.6	5	5	6
Output stage	kW	0-2-3	0-1.5-3	0-1.8-3.6	0-2.5-5	0-2.5-5	0-3-6
Current	A	9.1 / 13.5	4.0 / 4.6	4.4 / 5.1	10.7 / 12.0	6.5 / 7.5	7.1 / 8.2
Temp. increase due to heater	°C	21	21	25	20	20	24
Thermostat	°C	0-35	0-35	0-35	0-35	0-35	0-35
Sound pressure level ¹⁾	dB(A)	48	48	48	53	53	53
Air volume	m ³ /h	400	400	400	700	700	700
Weight	kg	12	12	12	12	12	12
Width	mm	300	300	300	300	300	300
Height	mm	375	375	375	375	375	375
Depth	mm	360	360	360	360	360	360



¹⁾ Measured at 5 metres in front of appliance.

Project Design/Orders

Description – Robust V

Electrical fan heater, VEAB type Robust V, with casing made of stainless sheet steel, EN 1.4016, grille made of stainless steel, EN 1.4301, and legs/wall bracket made of zinc-plated sheet steel lacquered with black epoxy. Robust V3, V3R and V3.6 come with heating elements made of acid-resistant stainless steel, EN 1.4404 and Robust V5, V5N, V6T and V6 come with heating elements made of stainless steel, EN 1.4301. The heating elements are electrically insulated from the casing. Heating element package and motor with reinforced fastenings. IP44 degree of protection. Feedback control is achieved by means of the integrated thermostat and the power selector. Optional RTC/RTC4 external control box to be ordered separately.

Accessories

	Product	Description	Degree of protection
	RTH For Robust H	External thermostat, temperature range 0-70 °C. 125x175x75 mm	IP44
	RTC For Robust C and V	Control box, for external control, with thermostat and operating mode switch. Temperature range 0-35 °C. 125x175x75 mm	IP65
	RTC4 For Robust C and V	Control box, for external control, with thermostat and operating mode switch. Able to control up to 4 appliances. Temperature range 0-35 °C. 254x360x111 mm	IP65



VEAB Heat Tech AB
Tel +46(0)451-485 00
www.veab.com • veab@veab.com
Sweden



EA
Electric fan heaters
for wall mounting

EA

Electric fan heaters for wall mounting

EA is a range of electric fan heaters with a broad output range intended for permanent heating of warehouses, Industrial premises, garages, drying rooms, and more. The simple clean design also makes the EA range suitable for public areas, such as stores.

- 5 different output variants from 6 kW to 30 kW
- Two fan speeds
- Integrated regulator and switches for low/high fan speed and continuous/intermittent fan operation
- Regulated with 0...10 V signal or room thermostat
- Air deflector for vertical adjustment of the outlet air
- Together with the thermostat MCD4-1999, complies with the Ecodesign directive 2009/125/EU and EU regulation 2015/1188.
- Wall bracket allows for continuous angular adjustment of the fan heater



Design

The casing is made of white lacquered galvanised sheet steel and the heating elements are made of stainless steel, EN 1.4301. The terminal box contains automation for temperature control. IP44 degree of protection (splash-proof execution) and approved for use in humid and wet areas (e.g. drying room).

Mounting/installation

Wall brackets are included.

EA is supplied with a type OK 2 external switch used for turning the heating fan on/off, and to limit power consumption. An EA with a connected sensor/thermostat can control an unlimited amount of slaved EA units. The slave-controlled units receive their control signal from the EA which has a sensor/thermostat connected.



OK2

Accessories

See page 5.

Approvals

Fan heater tested and approved by Intertek Semko AB according to:

LVD directive: EN 60335-1 and EN 60335-2-30

EMC directives: EN 61000-6-1, EN 61000-6-2, EN 61000-6-3 and EN 61000-6-4

EMF directive: EN 62233



Control Unit

If several EA heaters are installed in the same room, they can be coordinated. A thermostat, a sensor or a 0...10 V signal can control an unlimited number of EA units. For more detailed information on control, refer to p. 4.

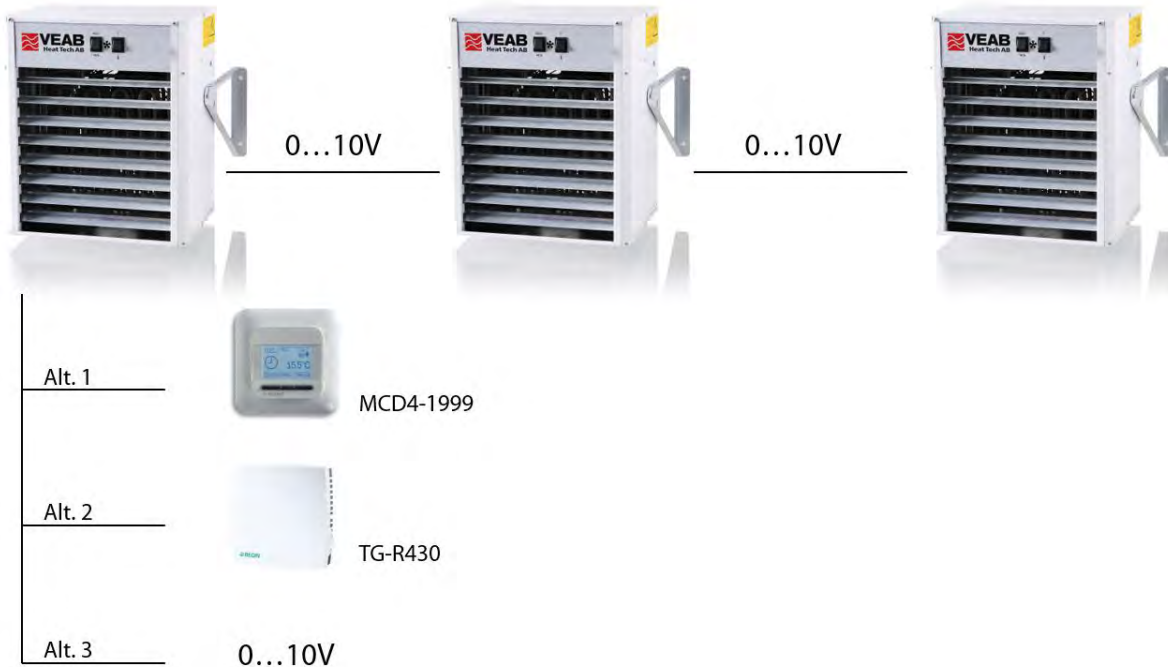

Product Range Overview

Type		EA 6	EA 9	EA 14	EA 21	EA 30
Voltage	V	400 VAC 3-ph. N 50/60 Hz	400 VAC 3-ph. N 50/60 Hz	400 VAC 3-ph. N 50/60 Hz	400 VAC 3-ph. N 50/60 Hz	400 VAC 3-ph. N 50/60 Hz
Current	A	8.8	13.1	20.4	30.5	43.5
Output	kW	6	9	14	21	30
Output stage	kW	0-3-6	0-6-9	0-7-14	0-14-21	0-20-30
Air volume (low/high speed)	m ³ /h	970 / 1300	970 / 1300	1950 / 2650	1950 / 2650	2800 / 3900
Temp. increase due to heater (low/high speed)	°C	17 / 13	26 / 19	20 / 15	30 / 22	30 / 21
Max. horizontal range (low/high speed)	m	10 / 13	10 / 13	11 / 15	11 / 15	12 / 16
Sound pressure level ¹⁾ (low/high speed)	dB(A)	45 / 54	45 / 54	48 / 57	48 / 57	56 / 63
Weight	kg	15	16	30	33	43
Dimensions excl. wall bracket, W × H × D	mm	388 × 453 × 350	388 × 453 × 350	552 × 610 × 385	552 × 610 × 385	552 × 610 × 505
Dimensions incl. wall bracket, W × H × D	mm	388 × 453 × 475	388 × 453 × 475	552 × 610 × 510	552 × 610 × 510	552 × 610 × 615
Degree of protection		IP44	IP44	IP44	IP44	IP44

¹⁾ Measured at 5 metres in front of appliance.

Project Design/Orders

Description – EA

Electrical fan heater, VEAB type EA, with casing made of white lacquered sheet steel and heating elements made of stainless steel, EN 1.4301 IP44 degree of protection. EA heaters are supplied with wall brackets and external switch (type OK2). Feedback control is achieved by means of the MCD4-1999 room thermostat or an external 0...10 V control signal. Outside the EU, sensors can also be used. Accessories such as a thermostat and sensor must be ordered separately.

Feedback Control

A. MCD4-1999 room thermostat

For installations within the EU, locations which are heated for the comfort of people must meet the Ecodesign directive 2009/125/EU and EU regulation 2015/1188. To do so, an external MCD4-1999 thermostat (ordered separately, see page 5) must be fitted.

The thermostat has a built-in clock and calendar which can be programmed for lowering the temperature, e.g. during nights and weekends. Transition from reduced to normal temperatures can be adapted so that a comfortable temperature is achieved at the desired time (adaptive function).



MCD4-1999

B. External 0...10V control signal

The EA series can also be controlled by an external 0...10V signal, in such cases, it is the installer's responsibility to utilise control equipment which meets applicable regulations.

C. Sensors

For installations outside the EU, and for locations which are not heated for the comfort of people, a VEAB TG sensor can be used (ordered separately, see page 5).

Opt. C1. Combined setpoint adjuster and room sensor



TG-R430 as setpoint adjuster and room sensor.

Opt. C2. Separate setpoint adjuster and separate sensor.



TG-R430 as setpoint adjuster.



TG-R530 (IP30) or TG-R630 (IP54) as room sensor.

Accessories

	Product	Range	Degree of protection
	<p>MCD4-1999 room thermostat Supplied with a frame which enables external mounting.</p>	<p>5 °C - 40 °C</p>	<p>IP21</p>
	<p>Room sensor TG-R430 With setpoint adjustment.</p>	<p>Range 0-30 °C</p>	<p>IP30</p>
	<p>Room sensor TG-R530 The desired temperature is adjusted on the TG-R430.</p>	<p>Range 0-30 °C</p>	<p>IP30</p>
	<p>Room sensor TG-R630 The desired temperature is adjusted on the TG-R430.</p>	<p>Range 0-30 °C</p>	<p>IP54</p>
	<p>Air deflector EALH Aluminium deflector blades. Direct air flow sideways.</p>		



VEAB Heat Tech AB
Tel +46(0)451-485 00
www.veab.com • veab@veab.com
Sweden

ENV-L
Electric fan heaters
for wall mounting

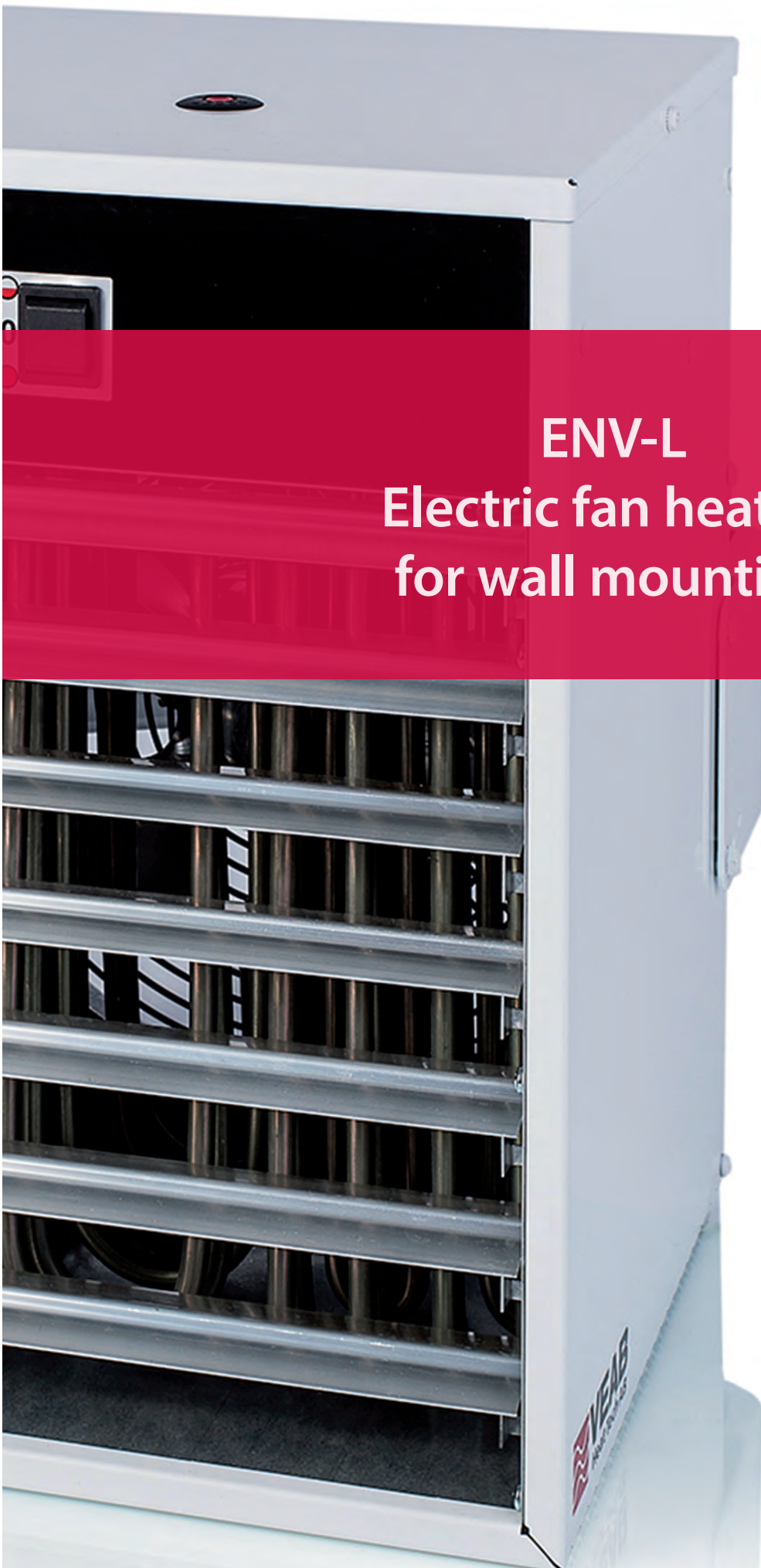

ENV-L

Electric fan heaters for wall mounting

The ENV-L series, with an output range up to 15 kW, is intended for permanent heating of warehouses, industrial premises, garages, drying rooms, and more.

- Five different output variants from 2 kW to 15 kW
- Continuous or intermittent fan operation
- Wall bracket allows for vertical and horizontal angular adjustment of the fan heater
- Air deflector for vertical adjustment of the outlet air
- Complies with the Ecodesign directive 2009/125/EU and EU regulation 2015/1188.
- Supplied with room thermostat

Design

The casing is made of white lacquered galvanised sheet steel and the heating elements are made of stainless steel, EN 1.4301.

The supplied wall brackets allow for angular adjustment in various directions.

IP44 degree of protection (splash-proof execution) and approved for use in humid and wet areas (e.g. drying room).

Feedback Control

Temperature adjustment as well as switching on/off are performed with the supplied electronic room thermostat MCD4-1999.

The thermostat has a built-in clock and calendar which can be programmed for lowering the temperature, e.g. during nights and weekends. Transition from reduced to normal temperatures can be adapted so that a comfortable temperature is achieved at the desired time (adaptive function).

The above functions are a requirement to meet the Ecodesign directive 2009/125/EU and EU regulation 2015/1188, for locations which are heated for the comfort of people.

ENV-L cannot be controlled as a slave.

MCD4-1999 is supplied with a frame that enables surface-mounted installation. IP21 degree of protection.



MCD4-1999

Approvals

Our fan heaters are produced in accordance with the following directives:

LVD directive: EN 60335-1 and EN 60335-2-30

EMC directives: EN 61000-6-2 and EN 61000-6-3

EMF directive: EN 62233



Product Range Overview

Type		ENV-L 2	ENV-L 3	ENV-L 5	ENV-L 9	ENV-L 15
Voltage	V	230 VAC 1-ph. 50/60 Hz	230 VAC 1-ph. 50/60 Hz	400 VAC 3-ph. N 50/60 Hz	400 VAC 3-ph. N 50 Hz	400 VAC 3-ph. N 50 Hz
Current, max.	A	8.7	13.0	7.2	13.0	21.7
Output	kW	2	3	5	9	15
Output stage	kW	0-1-2	0-1.5-3.0	0-3.3-5.0	0-6-9	0-7.5-15
Air volume	m ³ /h	270	270	390	900	970
Temp. increase due to heater	°C	21	31	36	28	43
Sound pressure level ¹⁾	dB(A)	43	43	47	53	54
Degree of protection		IP44	IP44	IP44	IP44	IP44
Weight	kg	6.5	6.6	7.0	11.0	13.4
Width	mm	232	232	232	307	307
Height	mm	318	318	318	402	402
Depth (incl. bracket)	mm	325	325	325	395	395

¹⁾ Measured at 5 metres in front of appliance.

Installation

ENV-L are to be mounted horizontally on walls and can angled downward by 10 or 20 degrees. The wall bracket also allows for the fan heater to be angled sideways by 30 degrees.



Project Design/Orders

Description – ENV-L

Electrical fan heater, VEAB type ENV-L, with casing made of white lacquered sheet steel and heating elements made of stainless steel, EN 1.4301 ENV-L can be angled downwards by 10 or 20 degrees, as well as 30 degrees sideways. IP44 degree of protection. Temperature control is achieved by means of the supplied room thermostat MCD4-1999.



VEAB Heat Tech AB
Tel +46(0)451-485 00
www.veab.com • veab@veab.com
Sweden

BX



VEAB
Heat Tech AB

Nicht bedecken Do not cover Ne pas couvrir Non coprire Niet afdekken

BX
**Portable/wall-mounted
electric fan heater**



BX

Portable/wall-mounted electric fan heater

The BX series has a solid build for demanding environments.

The fans are used anywhere there is a need for temporary but efficient heating.

Construction sites, warehouses, workshops, stores, exhibition halls, meeting halls and garages are but a few examples.

- Seven different outputs from 2 kW to 30 kW
- power selector 0 - 1/2 - 1/1 power
- Two-metre connection cable
- 3-year warranty
- BX 2E-15E have dials on the heater front panel to change between continuous and intermittent fan operation.

Design

The casing is made of red lacquered galvanised sheet steel and the heating elements are made of stainless steel, EN 1.4301. BX 9AE and BX 9ANE have a switch on the front panel for low or high fan speed. IPX4 degree of protection (splash-proof execution) and approved for use in humid and wet areas (e.g. construction sites).

Feedback Control

Thermostat-controlled heat adjustment with capillary tube thermostat (0 °C to +35 °C) that measures the inlet air temperature, which provides high accuracy.

Connection

BX 2E and BX 3E come with an earthed plug and a rubber connection cable.

BX 5E, BX 5EN, BX 9SE and BX 9AE come with a rubber connection cable and 16 A plug (CEE socket).

BX 5ER and BX 15EN come with a rubber connection cable without plug.

BX 9ANE, BX 15E and BX 20E come with a rubber connection cable and a 32 A plug (CEE socket).

BX 30E comes a rubber connection cable and a 63 A plug (CEE socket).

BX 9AE, BX 9SE and BX 15E do not require an earthed neutral point in the outlet owing to their 400 V motor, which is an advantage in many older plants.



Approvals

Fan heater tested and approved by Intertek Semko AB according to:

LVD directive: EN 60335-1 and EN 60335-2-30

EMC directives: EN 61000-6-2, EN 61000-6-3, EN 61000-6-1 (BX 20/30)

EMF directive: EN 62233



Product Range Overview

Type		BX 2E	BX 3E	BX 5E	BX 5EN	BX 5ER	BX 9SE	BX 9AE	BX 9ANE ³⁾
Voltage	V	230 VAC 1-ph. 50/60 Hz	230 VAC 1-ph. 50/60 Hz	400 VAC 3-ph. N 50/60 Hz	230 VAC 3-ph. 50/60 Hz	230 VAC 1-ph. 50/60 Hz	400 VAC 3-ph. 50 Hz	400 VAC 3-ph. 50 Hz	230 VAC 3-ph. 50 Hz
Output	kW	2	3	5	5	5	9	9	9
Output stage	kW	0-1-2	0-1.5-3	0-2.5-5	0-2.5-5	0-3.3-5	0-4.5-9	0-4.5-9 ²⁾	0-4.5-9 ²⁾
Current	A	4.3 / 8.7	6.5 / 13.0	6.3 / 7.2	10.9 / 12.6	14.5 / 21.7	11.3 / 13.0	6.5 / 13.0	11.3 / 22.6
Sound pressure level ¹⁾	dB(A)	39	44	47	47	47	53	42/53	44/53
Air volume	m ³ /h	190	290	500	500	500	900	700/900	700/900
Motor speed	rpm	1300	1300	1300	1300	1300	1300	1000/1300	1000/1300
Temp. increase due to heater	°C	29	29	28	28	28	28	36/28	36/28
Degree of protection		IPX4	IPX4	IPX4	IPX4	IPX4	IPX4	IPX4	IPX4
Weight	kg	5.3	5.7	6.9	6.8	6.7	10.4	11.0	11.1
Width	mm	275	275	275	275	275	350	350	350
Height	mm	340	340	340	340	340	415	415	415
Depth (incl. bracket)	mm	345	345	345	345	345	440	440	440

¹⁾ Measured at 5 metres in front of appliance. ²⁾ Uniform phase load even at half/reduced output. ³⁾ Fan motor is in continuous operation.

Type		BX 15E	BX 15EN	BX 20E ³⁾	BX 30E ³⁾
Voltage	V	400 VAC 3-ph. 50 Hz	230 VAC 3-ph. 50 Hz	400 VAC 3-ph. N 50 Hz	400 VAC 3-ph. N 50 Hz
Output	kW	15	15	20	30
Output stage	kW	0-7.5-15 ²⁾	0-7.5-15 ²⁾	0-10-20 ²⁾	0-20-30 ²⁾
Current	A	10.8 / 21.7	19.3/38.2	15.0/29.5	29.5/43.9
Sound pressure level ¹⁾	dB(A)	55	55	56	59
Air volume	m ³ /h	1000	1000	1750	2200
Motor speed	rpm	1300	1300	1100	1300
Temp. increase due to heater	°C	42	42	32	38
Degree of protection		IPX4	IPX4	IPX4	IPX4
Weight	kg	13.8	14.5	25	30
Width	mm	350	350	570	570
Height	mm	415	415	570	570
Depth (incl. bracket)	mm	440	440	570	610

¹⁾ Measured at 5 metres in front of appliance. ²⁾ Uniform phase load even at half/reduced output. ³⁾ Fan motor is in continuous operation.



BX

Power Requirements

The table below provides an estimate of the output that needs to be fed into an insulated room to keep it heated continuously.

To quickly heat a cold room, the output in the table must be doubled.

Temperature increase ²⁾ Δ t °C	BX 2 2 kW	BX 3 3 kW	BX 5 5 kW	BX 9 9 kW	BX 15 15 kW	BX 20 20 kW
	Volume of room in m ³ ¹⁾					
20 °C	100-150	150-230	255-370	450-670	750-1100	1000-1500
30 °C	70-100	100-150	170-250	300-450	500-750	700-1000
40 °C	50-75	75-110	130-190	220-340	370-550	500-750

¹⁾ The lower values apply to somewhat less well insulated rooms.

²⁾ Temperature increase (Δ t °C) is the difference between the indoor and outdoor temperatures on the coldest days of the year.



VEAB Heat Tech AB
Tel +46(0)451-485 00
www.veab.com • veab@veab.com
Sweden



KX 2

Portable electric fan heater

KX 2

Electric fan heater for temporary heating

KX 2 is a compact and convenient fan heater, that quickly heats up smaller spaces such as caravans, summer houses, winter gardens and garages.

- Powerful: 2000 W
- Thermostat and power selector 0-1-2 kW
- Self-limiting ceramic PTC element
- Carrying handle—easy to move
- Two-metre connection cable

Design

The casing is made of stainless steel EN 1.4016 and the frame of black lacquered galvanised steel sheet.

IP21 degree of protection (protected against dripping water).
If the KX 2 is used outdoors, it must be placed under a roof.

Feedback Control

KX 2 operates with a self-limiting ceramic PTC element and low air volume. This results in very intensive heat as the air temperature increases by about 65 °C as it flows through the KX 2.

The fan heater comes with a +5 °C to 35 °C thermostat and a 0-1-2 kW power selector.

Connection

KX 2 comes with two-metre long connection cable with an earthed plug.



Approvals

The fan heater has been tested and approved by Intertek Semko AB in accordance with the following directives:

LVD directive: EN 60335-1 and EN 60335-2-30

EMC directives: EN 61000-3-2, EN 61000-3-3, EN 55014-1 and EN 55014-2

EMF directive: EN 62233



Technical Data

		KX 2
Voltage	V	230 VAC 1-ph.
Output	kW	2
Output stage	kW	0-1-2
Current	A	4.3 / 8.7
Sound pressure level ¹⁾	dB(A)	43
Air volume	m ³ /h	90
Temp. increase due to heater	°C	65
Degree of protection		IP21
Weight	kg	2.4
Width × Height × Depth	mm	155 × 220 × 190

¹⁾ Measured at 5 metres in front of appliance.





VEAB Heat Tech AB
Tel +46(0)451-485 00
www.veab.com • veab@veab.com
Sweden



AW C, AW CE, AW D, AW Ex and AW H
Hot water fan heaters for
demanding environments



AW C, AW CE, AW D, AW Ex and AW H

Fan heaters for demanding environments

AW fans for harsh environments are a range of fan heaters that are suitable for environments with stringent requirements in terms of materials and safety, such as offshore, corrosive environments or the chemical industry. All fan heaters are easy to install.

AW fans are available in two sizes and five different models.

- Two sizes and five models
- Stainless chassis
- Intended for wall mounting
- Easy 230 VAC 1-ph. installation (AW Ex 400 VAC 3-ph.)
- Adjustable air deflectors control vertical air flow
- AW CE/Ex/H come with an inspection access point for cleaning of fan and coil
- AW C/D come with opening front panel for easy cleaning
- All models are intended for external control

Design

Each model has a unique design to fit a specific environment.

AW C for corrosive environments, see page 4

AW CE for corrosive environments, see page 6

AW D for dusty environments, see page 8

AW Ex for Ex-rated environments, see page 10

AW H for environments with a high ambient temperature, see page 12



Approvals

Our fan heaters are produced in accordance with the following directives:

LVD directive: EN 60355-1 and EN 60335-2-30

EMC directives: EN 61000-6-1, EN 61000-6-2, EN 61000-6-3 and EN 61000-6-4

EMF directive: EN 62233

For approvals for AW Ex, see page 10.





AW CE, AW Ex and AW H come with an inspection-access point with quick release, which facilitates inspection and cleaning.



AW C and AW D come with an opening front panel.



The opening front panel on AW C and AW D facilitates inspection and make it easier to clean the fan and coil.

AW C

Fan heaters for corrosive environments

AW C heating fans have been specially designed for wall mounting in corrosive environments, such as offshore or the chemical industry. AW C fan heaters feature IP65 protection against dust and water jets.

- Uses hot water as the energy medium
- Intended for use in humid and corrosive environments
- Meets the requirements for corrosion class C5-M
- Casing and bracket made of acid-resistant stainless steel, EN 1.4404
- Coil with acid-resistant stainless steel pipes, EN 1.4404
- Aluminium fins with nanocoating (meets corrosion class C5-M)
- IP65 degree of protection—protected against dust and water jets

Design

Casing and air deflectors are made of acid-resistant stainless steel, EN 1.4404. Coil with acid-resistant stainless steel pipes, EN 1.4404 and aluminium films with nanocoating. Opening front panel for easy cleaning. IP65 degree of protection (protected against dust and water jets). Supplied with a wall bracket.

Control Unit

AW C fan heaters are supplied without any automation and a single fan speed.

Dimensioning

Dimensioning can easily be achieved with our web-based calculation program VEAB Select (www.veab.com).

If necessary, contact our sales staff for help.

Dimensional Drawing

See page 14.





Project Design/Orders

Description – AW C

Hot water fan heater, VEAB type AW C, with casing and air deflectors made of acid-resistant stainless steel, EN 1.4404. Coil with acid-resistant stainless steel pipes, EN 1.4404 and aluminium films with nanocoating. Meets the requirements for corrosion class C5-M. Opening front panel for easy cleaning. IP65 degree of protection. Supplied with a wall bracket. Accessories such as thermostat and filter ordered separately.

Accessories (To be ordered separately)

	Product	Description
	Valve VM 8622-3.6 for AW C22	Stainless steel, EN 1.4401 230 V, IP65 degree of protection 140 °C, 16 bar max. VM 8622 Kv 3.6, 3/4" connection VM 8622 Kv 8.4, 1" connection
	Valve VM 8622-8.4 for AW C42	
	Thermostat AWST35	Sealed thermostat 0-35 °C. IP65 degree of protection 2.6 A AC3
	Flat filter AWPFC	Max. hot water temperature at the installed filter is 100 °C.

Product Range Overview

Type		AW C22	AW C42
Voltage		230 VAC 1-ph. 50/60Hz	230 VAC 1-ph. 50/60 Hz ³⁾
Power consumption, max.	A	0.5	1.35
Air volume	m ³ /h	2160	4300
Sound pressure level ¹⁾	dB(A)	59	69
Horizontal range	m	7	10
Connector pipe		R3/4"	R3/4"
Max. operating temp. water	°C	150	150
Max. operating pressure water	bar	16	16
Max. ambient temperature	°C	70 ²⁾	70 ²⁾
Weight	kg	31	47
Degree of protection		IP65	IP65

¹⁾ Measured at 5 metres in front of AW unit.

²⁾ 35 °C using VEAB's thermostat.

³⁾ AW C42, 60 Hz max. 40 °C ambient temperature.

AW CE

Fan heaters for corrosive environments

The AW CE was specially designed for wall-mounting in corrosive environments, such as offshore or chemical industry. It features IP65 protection class, protected against dust and water jets.

- Uses hot water as the energy medium
- Intended for use in humid and corrosive environments
- Coil coated with ElectroFin E-coat and meets the requirements of corrosion classes C5-I and C5-M.
- Casing and wall bracket made of acid-resistant stainless steel, EN 1.4404
- Cleaning cover with snap lock
- IP65 degree of protection (protected against dust and water jets)

Design

Casing and air deflectors made of acid-resistant stainless steel, EN 1.4404. Coil with copper pipes and aluminium fins coated with ElectroFin E-coat. This means that the entire coil is double-painted with flexible epoxy polymer with 100% degree of cover. Thermal loss is less than 1%. The coil thereby fulfils the requirement for corrosion classes C5-I and C5-M. Cleaning cover with snap lock for ease of cleaning. IP65 degree of protection (protected against dust and water jets). Supplied with a wall bracket.



Control Unit

Supplied without any automation and a single fan speed.

Dimensioning

Dimensioning can easily be achieved with our web-based calculation program VEAB Select (www.veab.com).

If necessary, contact our sales staff for help.

Dimensional Drawing

See page 15.

Project Design/Orders

Description – AW CE

Hot water fan heater, VEAB type AW CE, with casing and air deflectors made of acid-resistant stainless steel, EN 1.4404. Coil with copper pipes and aluminium fins coated with ElectroFin E-coat. Thereby fulfils the requirement for corrosion classes C5-I and C5-M. Cleaning cover with snap lock for ease of cleaning. IP65 degree of protection. Supplied with a wall bracket. Accessories such as thermostat and filter ordered separately.

Product Range Overview



Type		AW C22E	AW C42E
Voltage		230 VAC 1-ph. 50/60Hz	230 VAC 1-ph. 50/60 Hz ²⁾
Power consumption, max.	A	0.5	1.35
Air volume	m ³ /h	2100	4200
Sound pressure level ¹⁾	dB(A)	59	69
Horizontal range	m	7	10
Connector pipe		R3/4"	R1"
Max. operating temp. water	°C	150	150
Max. operating pressure, water	bar	16	16
Max. ambient temperature	°C	70 ²⁾	70 ²⁾
Weight	kg	29	45
Degree of protection		IP65	IP65

¹⁾ Measured at 5 metres in front of AW unit.

²⁾ 35 °C using VEAB's thermostat.

³⁾ AW C42E, 60 Hz max. 40 °C ambient temperature.

Accessories (To be ordered separately)

	Product	Description
	Valve VM 8622-3.6 for AW C22E	Stainless steel, EN 1.4401 230 V, IP65 degree of protection 140 °C, 16 bar max. VM 8622 Kv 3.6, 3/4" connection VM 8622 Kv 8.4, 1" connection
	Valve VM 8622-8.4 for AW C42E	
	Thermostat AWST35	Sealed thermostat 0-35 °C. IP65 degree of protection 2.6 A AC3
	Flat filter AWPFH	Max. hot water temperature at the installed filter is 100 °C.

AW D

Fan heaters for dusty environments

AW D fan heaters have been developed to heat the air in dusty environments such as industrial and wood-working premises.

- Uses hot water as the energy medium
- Intended for use in dusty environments
- Casing made of acid-resistant stainless steel, EN 1.4404
- Coil with copper pipes
- Fin spacing 4.2 mm
- IP65 degree of protection—protected against dust and water jets

Design

Casing made of acid-resistant stainless steel, EN 1.4404.

Coil with copper pipes and aluminium fins.

4.2 mm fin spacing to minimise dust and particles clogging up the coil.

Opening front panel for easy cleaning.

IP65 degree of protection (protected against dust and water jets).

Supplied with a wall bracket.



Control Unit

AW D fan heaters are supplied without any automation and a single fan speed.

Dimensioning

Dimensioning can easily be achieved with our web-based calculation program VEAB Select (www.veab.com).

If necessary, contact our sales staff for help.

Dimensional Drawing



See page 14.

Project Design/Orders

Description – AW D

Hot water fan heater, VEAB type AW D, with casing made of acid-resistant stainless steel, EN 1.4404. Coil with copper pipes and aluminium fins. Opening front panel for easy cleaning. IP65 degree of protection. Supplied with a wall bracket. Accessories such as thermostat and filter ordered separately.

Accessories (To be ordered separately)

	Product	Description
	Valve VM 8631-8.4	230 V, IP65 degree of protection 140 °C, 16 bar max. Kv 8.4 ¾" connection
	Thermostat AWST35	Sealed thermostat 0-35 °C. IP65 degree of protection 2.6 A AC3
	Flat filter AWPFH	Max. hot water temperature at the installed filter is 100 °C.

Product Range Overview

Type		AW D22	AW D42
Voltage		230 VAC 1-ph. 50/60 Hz	230 VAC 1-ph. 50/60 Hz ²⁾
Power consumption, max.	A	0.5	1.35
Air volume	m ³ /h	2200	4430
Sound pressure level ¹⁾	dB(A)	59	69
Horizontal range	m	7	10
Connector pipe		R3/4"	R3/4"
Max. operating temp. water	°C	150	150
Max. operating pressure water	bar	16	16
Max. ambient temperature	°C	70 ²⁾	70 ²⁾
Weight	kg	30	46
Degree of protection		IP65	IP65

¹⁾ Measured at 5 metres in front of AW unit.

²⁾ 35 °C using VEAB's thermostat.

³⁾ AW D42, 60 Hz max. 40 °C ambient temperature.

AW Ex

Hot water fan heaters for hazardous areas

AW Ex fan heaters are specially designed for heating air in environments where potentially explosive atmospheres may occur (zones 1 and 2).

- Uses hot water as the energy medium
- Approved for use in areas where the risk of explosion is due to gases or vapours (equipment category 2G)
- Casing made of stainless sheet steel, EN 1.4016
- Coil with copper pipes
- Temperature class T4 (135 °C max.)
- Max. ambient temperature 40 °C
- IP44 degree of protection splash-proof
- Thermistor motor protection U-EK230E included.

Design

Stainless sheet steel casing, EN 1.4016. The water battery has copper pipes and aluminium fins. Quick release access point door for inspection and easier cleaning. IP44 degree of protection (splash-proof). Supplied with a wall bracket and thermistor motor protection.

Control Unit

AW Ex fan heaters come with an Ex-rated terminal block for the fan motor. To obtain AW Ex approval, the supplied thermistor motor protection must be installed.

Thermistor Motor Protection

The U-EK230E is a thermistor motor protection to be used together with a contactor to protect Ex fans. There are six thermistors connected in series in the AW Ex fan motors, two per phase winding, whose resistance is affected by the temperature. When the motor temperature exceeds the authorised temperature, the resistance surges and the motor protection is tripped. The U-EK230E must be placed outside an Ex-rated zone. Intended for snap on installation onto a DIN-rail.

Dimensioning

Dimensioning can easily be achieved with our web-based calculation program VEAB Select (www.veab.com). If necessary, contact our sales staff for help.



U-EK230E



II 2 G c Ex eb IIB T4 Gb

Dimensional Drawing

See page 15.

Approvals

AW Ex fan heaters are produced in accordance with the following directives:

LVD directive: EN 60355-1 and EN 60355-2-30

EMC directives: EN 61000-6-1, EN 61000-6-2, EN 61000-6-3 and EN 61000-6-4

EMF directive: EN 62233

AW Ex fan heaters meet the requirements of the ATEX directive 2014/34/EU.

VEAB's quality system is certified by Intertek in accordance with certificate ITS09ATEXQ6440

Testing and certification of AW Ex fan heaters are performed by Presafe in accordance with the following certificate: Presafe 15 ATEX 6095X.

Testing standards applied:



IP44 degree of protection, IEC/EN 60529

General ATEX requirements IEC/EN 60079-0

Ex e (increased safety) IEC/EN 60079-7



Accessories (To be ordered separately)

	Product	Description
	UE-K	UE-K, plastic enclosure for UE-K230E. IP65 degree of protection Dimensions: WxHxD (mm): 101 x 174 x 112
	Thermostat TRK	Thermostat with internal temperature setting. Temperature range: 0-50 °C, max, adjustment with AW-EX is +40 °C. Data: 16.0 A, 400 V. IP65 degree of protection. Temperature class T6. Classification EX II 2 G Ex de mb II C T6.
	Transformer RTRD 2	With RTRD 2 the fan motor in AW Ex can be adjusted in 5 stages. Data: 2.0 A, 3 x 400 V, 50 Hz. IP54 degree of protection. Dimensions: 240 x 284 x 132 mm (W x H x D) RTRD 2 must be placed outside an EX classed zone.

Product Range Overview

Type		AW Ex22	AW Ex42
Voltage		400 VAC 3-ph. 50Hz	400 VAC 3-ph. 50Hz
Power consumption, max.	A	0.27	0.51
Air volume	m ³ /h	2250	4150
Sound pressure level ¹⁾	dB(A)	61	67
Horizontal range	m	8	10
Connector pipe	mm	Ø22	Ø28
Max. operating temp. water	°C	125	125
Max. operating pressure, water	bar	16	16
Ambient temperature	°C	-20 °C - +40 °C	-20 °C - +40 °C
Weight	kg	25	42
Degree of protection, motor		IP44	IP44

¹⁾ Measured at 5 metres in front of AW unit.

Project Design/Orders

Description – AW Ex

Hot water fan heater, VEAB type AW Ex, with casing made of stainless sheet steel, EN 1.4016. Coil with copper pipes and aluminium fins. Quick release access point door for inspection and easier cleaning. Supplied with a wall bracket and thermistor motor protection. IP44 degree of protection. Accessories to be ordered separately.

Marking: Ex II 2 G c Ex e IIB T4 Gb

Casing material: Stainless steel EN 1.4016

Degree of protection: IP44

Temperature class: T4 (max. 135 °C)

Max. ambient temperature: -20 °C - +40 °C

AW H

Fan heaters for working conditions up to 70 °C

AW H fan heaters have been specially developed to heat the air in environments with a high ambient temperature, such as drying and curing industries as well as sanitation.

- Uses hot water as the energy medium
- Intended for environments with high ambient temperature
- Casing made of stainless sheet steel, EN 1.4016
- Coil with copper pipes
- Aluminium fins with hydrophilic coating for easier cleaning and improved durability, among others.
- IP65 degree of protection—protected against dust and water jets

Design

Stainless sheet steel casing, EN 1.4016. Coil with copper pipes and aluminium fins with hydrophilic coating. Quick release access point door for inspection and easier cleaning. IP65 degree of protection (protected against dust and water jets).
Supplied with a wall bracket.

Control Unit

AW H fan heaters are supplied without any automation and a single fan speed.

Dimensioning

Dimensioning can easily be achieved with our web-based calculation program VEAB Select (www.veab.com).

If necessary, contact our sales staff for help.

Dimensional Drawing

See page 15.





Project Design/Orders

Description – AW H

Hot water fan heater, VEAB type AW H, with casing made of stainless sheet steel, EN 1.4016. Coil with copper pipes and aluminium fins with hydrophilic coating. Quick release access point door for inspection and easier cleaning. Supplied with a wall bracket. Accessories such as thermostat and filter ordered separately.

Accessories (To be ordered separately)

	Product	Description
	Valve VM 8631-8.4	230 V, IP65 degree of protection 140 °C, 16 bar max. Kv 8.4 ¾" connection
	Thermostat AWST70	Nested thermostat 0-70 °C. IP65 degree of protection 2.6 A AC3
	Flat filter AWPFH	Max. hot water temperature at the installed filter is 100 °C.

Product Range Overview

Type		AW H22	AW H42
Voltage		230 VAC 1-ph. 50/60Hz	230 VAC 1-ph. 50Hz
Power consumption, max.	A	0.5	1.35
Air volume	m ³ /h	1830	3870
Sound pressure level ¹⁾	dB(A)	57	68
Horizontal range	m	6	9
Connector pipe	mm	22	28
Max. operating temp. water	°C	120	120
Max. operating pressure water	bar	16	16
Max. ambient temperature	°C	70	70
Weight	kg	28	46
Degree of protection		IP65	IP65

¹⁾ Measured at 5 metres in front of AW unit.

Dimensional Drawing

AW C

Dimensions	A mm	W mm	C mm	D mm	E	F mm	G mm	H mm	Ø I
AW C22	585	535	395	705	G 3/4"	250	330	410	10
AW C42	740	660	395	725	G 3/4"	270	420	505	10

AW D

Dimensions	A mm	W mm	C mm	D mm	E	F mm	G mm	H mm	Ø I
AW D22	585	535	395	705	G 3/4"	250	330	410	10
AW D42	740	660	395	725	G 3/4"	270	420	505	10

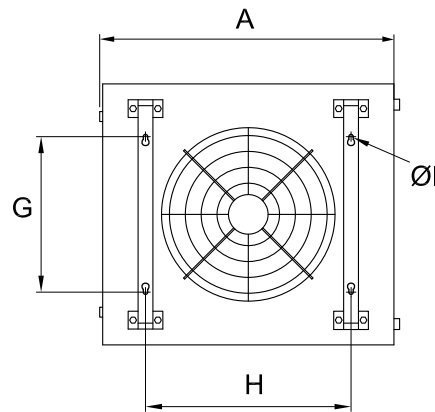
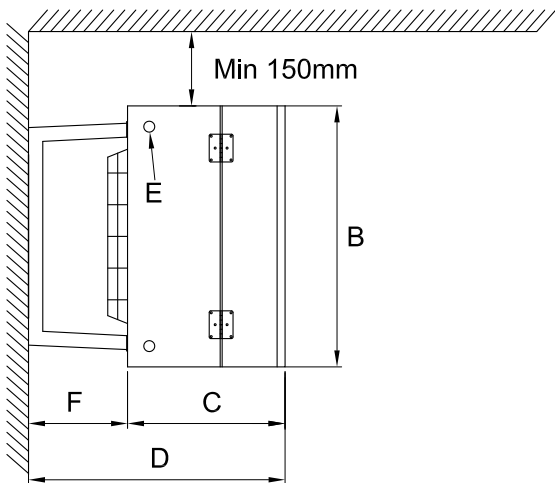

AW CE

Dimensions	A mm	W mm	C mm	D mm	E	F mm	G mm	H mm	Ø I
AW C22E	550	530	380	630	R 3/4"	250	330	410	10
AW C42E	705	655	430	700	R 1"	270	420	505	10

AW Ex

Dimensions	A mm	W mm	C mm	D mm	E mm	F mm	G mm	H mm	Ø I
AW Ex22	550	530	380	630	Ø22	250	330	410	10
AW Ex42	705	655	430	700	Ø28	270	420	505	10

AW H

Dimensions	A mm	W mm	C mm	D mm	E mm	F mm	G mm	H mm	Ø I
AW H22	550	530	380	630	Ø22	250	330	410	10
AW H42	705	655	430	700	Ø28	270	420	505	10

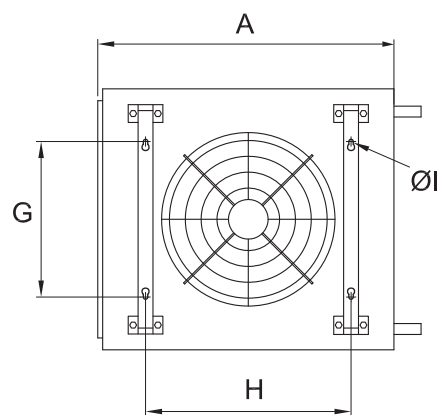
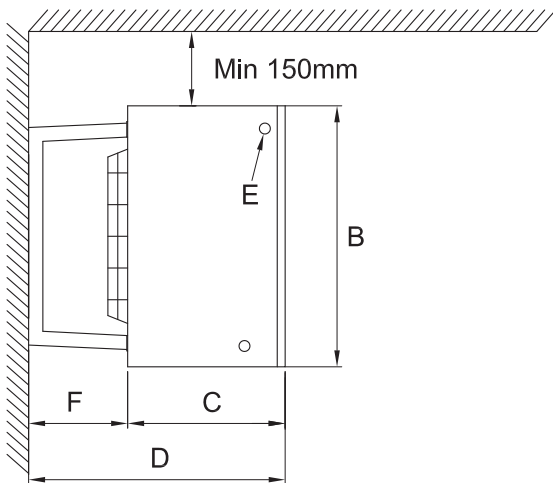



VEAB Heat Tech AB
Tel +46(0)451-485 00
www.veab.com • veab@veab.com
Sweden



AW DX22CE
Fan heaters for corrosive
environments

AW DX22CE

Wall-mounted indoor heat pump unit for corrosive environments.

The AW DX 22CE is used with an outdoor unit to heat and corrosive environments, e.g. in the chemical industries, sewage plants and car washes. It can be combined with different makes of outdoor units and their control equipment.

AW DX22CE fan heaters feature IP65 protection against dust and water jets.

- Designed for hot operation.
- Intended for use in humid and corrosive environments.
- Casing and wall bracket made of acid-resistant stainless steel, EN 1.4404.
- 3 mm fin spacing
- Coil coated with ElectroFin E-coat and meets the requirements of corrosion classes C5-I and C5-M.
- Cleaning cover with quick release.
- IP65 degree of protection (protected against dust and water jets).

Design

Casing and air deflectors are made of acid-resistant stainless steel, EN 1.4404. Coil with copper pipes and aluminium fins coated with ElectroFin E-coat.

This means that the entire coil is dip painted with flexible epoxy polymer with a 100% cover rate.

Thermal loss is less than 1%.

Cleaning plate with quick release for simple cleaning.

Supplied with a wall bracket.



Control Unit

AW DX22CE fan heaters are supplied without any automation and a single fan speed.

Dimensioning

Dimensioning can easily be achieved with our web-based calculation program VEAB Select (www.veab.com).

If necessary, contact our sales staff for help.

Approvals

Our fans are produced in accordance with the following directives:

LVD directive: EN 60355-1 and EN 60335-2-30

EMC directives: EN 61000-6-2 and EN 61000-6-3

EMF directive: EN 62233



Technical Data

Type	AW DX 22CE	
Voltage		230 VAC 1-ph. 50/60 Hz
Power consumption	A	0.5
Air volume	m ³ /h	2000
Sound pressure level ¹⁾	dB(A)	56
Max. operating pressure	MPa	4.15
Inner volume coil	l	2.1
Pipe connection cooling pipe, liquid/gas		3/8" - 5/8"
Max. ambient temperature	°C	40
Coolant		R410A
Degree of protection		IP65
Weight	kg	36

¹⁾ Measured at 5 metres in front of AW unit.

Dimensions	A mm	W mm	C mm	D mm	E mm	F mm	G mm	Ø H mm
AW DX22CE	680	505	460	250	710	330	450	10

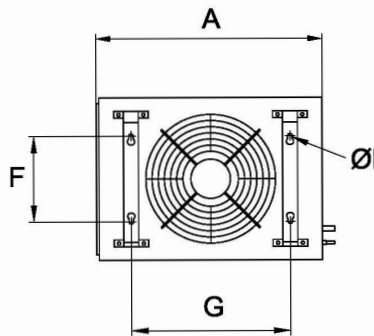
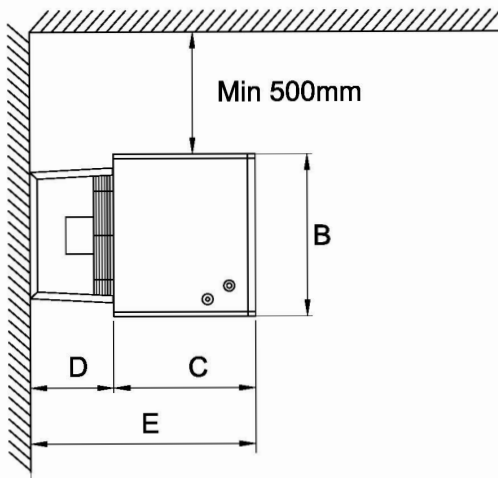

Model	A	B	C	D	E	F	G	ØH
AW DX22CE	680	505	460	250	710	330	450	10

Project Design/Orders

Description – AW DX22CE

Wall-mounted indoor unit for heat pump, VEAB type AW DX22CE, with acid-resistant sheet metal casing. EN 1.4404. Coil coated with ElectroFin E-coat and meets the requirements of corrosion classes C5-I and C5-M. Single speed fan motor. IP65 degree of protection. Supplied with a wall bracket.



VEAB Heat Tech AB
Tel.: +46(0)451-485 00
www.veab.com • veab@veab.com
Sweden



**AW DX and AW K
Cooling/heating fans**

AW DX

Wall-mounted indoor unit for heat pump

The AW DX is used with an outdoor unit to heat and cool various rooms. Ideal for use in industrial premises, warehouses, shops, and more.

Can be combined with outdoor units from different manufacturers and associated control equipment.

- Designed for heating and cooling operation.
- Condensation insulation between coil and casing.
- 4 mm fin spacing minimises maintenance, even in dusty surroundings.
- Hydrophilic coated fins for optimum condensation run-off.
- Stainless steel condensation trough, with condensation insulation underneath.
- Adjustable deflectors to control height of air flow.
- Snap lock cover to connect transmitter on coil.
- Snap lock cleaning cover.
- AC or EC motor.



Design

The casing is made of galvanised, white-painted steel plate. Coil with copper pipes and hydrophilic-plated aluminium fins. Fin spacing 4 mm to minimise dust and particles clogging up the coil. Ball bearing-mounted fan motor with thermal protection gives low noise and safe operation. Condensation drain with G $\frac{1}{2}$ " connection.

Connected to outdoor unit by soldering. Available in two sizes, complete with wall bracket.

IP44 degree of protection with AC motor.

IP54 degree of protection with EC motor.

Control Unit

AW DX has no automated control equipment and has to be controlled by the outdoor unit and its control equipment. AW DX has a single fan speed.

Dimensioning

Dimensioning can easily be achieved with our web-based calculation program VEAB Select (www.veab.com).

If necessary, contact our sales staff for help.

Dimensional Drawing

See page 6.

Approvals

Our fans are produced in accordance with the following directives:

LVD directive: EN 60355-1 and EN 60335-2-30

EMC directives: EN 61000-6-2 and EN 61000-6-3

EMF directive: EN 62233



Accessories (To be ordered separately)

	Product	Description
	Air vents AWLH DX22/DX42	Aluminium deflector blades. Direct air flow sideways.

Product Range Overview

Type		AW DX22	AW DX42	AW DX22-EC	AW DX42-EC
Voltage		230 VAC 1-ph.	230 VAC 1-ph.	230 VAC 1-ph.	230 VAC 1-ph.
Power consumption	A	0.6	0.95	0.55	1.35
Air volume	m ³ /h	2000	3500	2000	3500
Sound pressure level ¹⁾	dB(A)	52	62	51	59
Max. operating pressure	MPa	4.29	4.29	4.29	4.29
Inner volume coil	l	2.3	3.7	2.3	3.7
Pipe connection cooling pipe, liquid/gas		3/8" - 5/8"	3/8" - 5/8"	3/8" - 5/8"	3/8" - 5/8"
Condensation drain		G1/2"	G1/2"	G1/2"	G1/2"
Max. ambient temperature	°C	40	40	40	40
Coolant		R410A / R32	R410A / R32	R410A / R32	R410A / R32
Degree of protection		IP44	IP44	IP54	IP54
Weight	kg	48	63	47	62

¹⁾ Measured at 5 metres in front of AW unit.

Project Design/Orders

Description – AW DX

Wall-mounted indoor unit for heat pump, VEAB type AW DX, with white-painted galvanised sheet metal casing. Coil with copper pipes and hydrophilic-plated aluminium fins. 4 mm fin spacing minimises maintenance. Stainless steel condensation trough, with condensation insulation underneath. Single speed fan motor. IP44 degree of protection. Supplied with a wall bracket. Deflectors ordered separately.

AW K

Fan air heater/cooler for installations using water as the energy medium

AW K is used to cool industrial premises, shops and similar types of premises. Clean design with simple lines mean that the AW range can also be installed in public areas. The AW K can be connected to a hot water supply, and used for heating during the cold season.

- Designed for cooling and heating.
- Stainless steel condensation trough, with condensation insulation underneath.
- 4 mm fin spacing minimises maintenance, even in dusty surroundings.
- Adjustable deflectors to control height of air flow.
- Supplied with a wall bracket.
- AC or EC motor.

Design

The casing is made of galvanised, white-painted steel plate. Coil with copper pipes and hydrophilic-plated aluminium flanges. Fin spacing 4 mm to minimise dust and particles clogging up the coil. Ball bearing-mounted fan motor with thermal protection gives low noise and safe operation. Condensation drain with G $\frac{1}{2}$ " connection. Available in two sizes, complete with wall bracket. IP44 degree of protection with AC motor. IP54 degree of protection with EC motor.



Dimensioning

Dimensioning can easily be achieved with our web-based calculation program VEAB Select (www.veab.com).

If necessary, contact our sales staff for help.

Dimensional Drawing

See page 7.

Approvals

Our fans are produced in accordance with the following directives:





LVD directive: EN 60355-1 and EN 60335-2-30

EMC directives: EN 61000-6-2 and EN 61000-6-3

EMF directive: EN 62233



Accessories

	Product	Range	Degree of protection
	Valve with actuator AWTV 42-62, IP44 To be used together with thermostat R31 or SR 121/1.	Max. 90°C 25 bar	IP44
	Thermostat SR 121/1 Can control two AW Ks.	Range 0-40 °C	IP54
	Room thermostat R31 Can control one AW K.	Range 7-30°C	IP20
	AWLH K22/K42 Aluminium deflector blades. Direct air flow sideways.		

Product Range Overview

Type		AW K22	AW K42	AW K22-EC	AW K42-EC
Voltage		230 VAC 1-ph.	230 VAC 1-ph.	230 VAC 1-ph.	230 VAC 1-ph.
Power consumption, max.	A	0.6	0.95	0.55	1.35
Air volume	m ³ /h	2000	3500	2000	3500
Sound pressure level ¹⁾	dB(A)	52	62	51	59
Horizontal range	m	8	8	8	8
Connector pipe	mm	Ø28	Ø28	Ø28	Ø28
Max. operating temp. water	°C	120	120	120	120
Max. operating pressure water	bar	16	16	16	16
Max. ambient temperature	°C	50	50	40	40
Weight	kg	51	66	50	65
Degree of protection		IP44	IP44	IP54	IP54

¹⁾ Measured at 5 metres in front of AW unit.

Project Design/Orders

Description – AW K

Fan air cooler/heater for cold/hot water, VEAB type AW K, with white-painted galvanised sheet metal casing. Coil with copper pipes and hydrophilic-plated aluminium fins. 4 mm fin spacing minimises maintenance. Stainless steel condensation trough, with condensation insulation underneath. Single speed fan motor. IP44 degree of protection. Supplied with a wall bracket. Accessories including thermostat, valve and deflectors to be ordered separately.

Dimensional Drawing

AW DX

Dimensions	A mm	W mm	C mm	D mm	E mm	F mm	G mm	Ø H mm
AW DX22	740	670	510	270	780	420	515	10
AW DX42	920	875	510	270	780	550	700	10

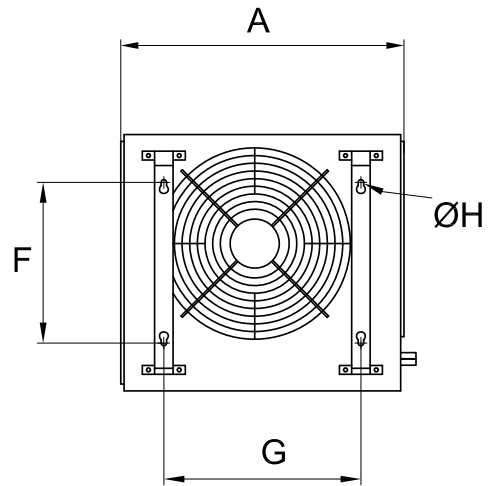
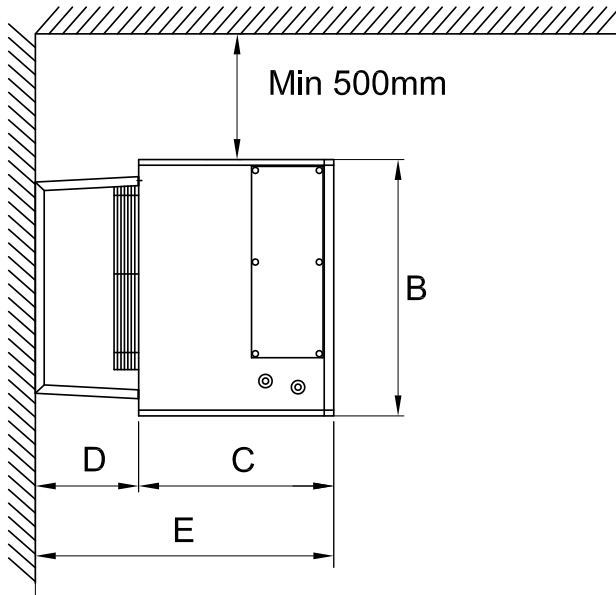

AW DX / K

AW K

Dimensions	A mm	W mm	C mm	D mm	∅ E mm	F mm	G mm	H mm	∅ I mm
AW K22	730	670	510	780	28	270	420	515	10
AW K42	920	875	510	780	28	270	550	700	10

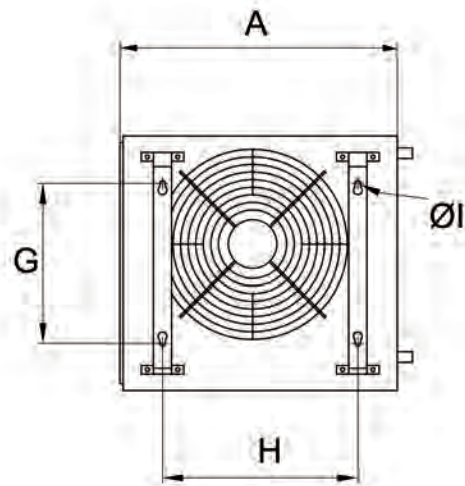
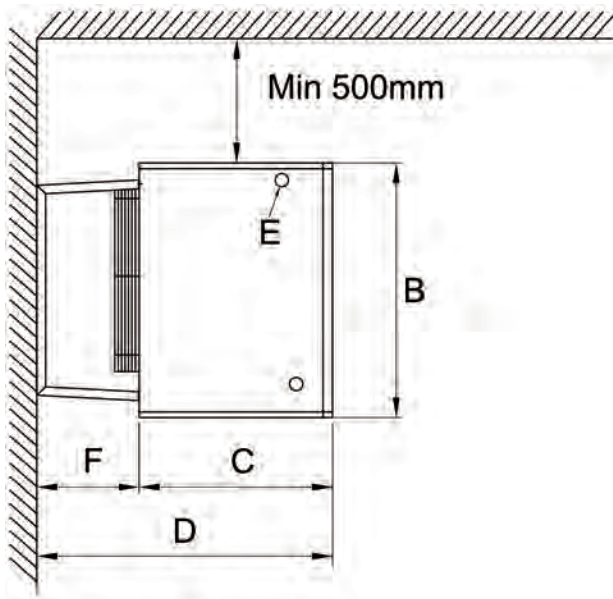



VEAB Heat Tech AB
Tel +46(0)451-485 00
www.veab.com • veab@veab.com
Sweden



AW
Fan heaters for hot water

AW

Fan heaters for hot water

AW fan heaters are used for permanent heating of warehouses, industrial plants, workshops, shops and similar premises.

Beautiful design with simple clean lines mean that the AW range can also be installed in public areas. The AW series is available in four different sizes and two different models. All fans are for 230 VAC 1-ph., which makes their installation very easy.

The fans are available in both AC and EX execution.

- Four sizes and two models
- Available with integrated control equipment for sensor control or for external 0...10 V control signal
- Low noise level—suitable for most environments
- Three fan speeds as standard
- Easy 230 VAC 1-ph. installation
- Air deflectors control the vertical air flow

Design

The casing is made of galvanised, white-painted steel plate.

The coil has copper pipes and aluminium fins.

Ball bearing-mounted fan with thermal protection ensures low noise and safe operation.

Supplied with a wall bracket.

AW fan heaters are available in two models, AW-a and AW-s.

Dimensioning

Dimensioning can easily be achieved with our web-based calculation program VEAB Select (www.veab.com).

If necessary, contact our sales staff for help.

Installation

AW fan heaters are mounted on walls using the AWW wall bracket or on the ceiling using the AWT ceiling bracket.

Dimensional Drawing

See page 6.



Control Unit

Integrated Control Equipment -a

Fan heater with integrated control equipment for external sensor and setpoint adjustment. Can also be controlled by an external 0...10 V control signal. See pages 4 and 5.

External Control Equipment -s

Fan heater for external control equipment. Has three fan speeds. See pages 6 and 7.

Approvals

Our fan heaters are produced in accordance with the following directives:

LVD directive: EN 60355-1 and EN 60335-2-30

EMC directives: EN 61000-6-2 and EN 61000-6-3

EMF directive: EN 62233



Product Range Overview

Type		AW13	AW23	AW43	AW63
Voltage/Frequency		230 VAC 1-ph. 50/60 Hz	230 VAC 1-ph. 50/60 Hz	230 VAC 1-ph. 50/60 Hz	230 VAC 1-ph. 50 Hz
Power consumption 50/60 Hz	A	0.4 / 0.45	0.6 / 0.75	0.9 / 1.25	2.2
Air volume (low/medium/high speed)	m ³ /h	600 / 900 / 1250	900 / 1250 / 2200	1900 / 2500 / 3700	2200 / 3400 / 5200
Sound pressure level ¹⁾ (low/medium/high speed)	dB(A)	39 / 44 / 51	41 / 45 / 58	43 / 53 / 61	45 / 54 / 68
Horizontal range ²⁾ (high speed)	m	4.5	7.0	9.0	14.0
Horizontal range with AWLA ²⁾ (high speed)	m	6.5	10.0	12.5	19.0
Connector pipe	Ø mm	22	22	28	28
Max. operating temp. water, AW-a	°C	100	100	100	100
Max. operating temp. water AW-s	°C	150	150	150	150
Max. operating pressure (of water)	bar	10	10	10	10
Max. ambient temperature	°C	30	30	30	30
Can be ordered for execution -a		X	X	X	X
Can be ordered for execution -s		X	X	X	X
Weight	kg	17	23	32	46
Degree of protection		IP44	IP44	IP44	IP44

¹⁾ Measured at 5 metres in front of AW unit.

²⁾ Horizontal range shown applies for inlet air temperature of +40 °C and room temperature of +18 °C. The horizontal range is defined as the distance from the fan air heater to the point where air velocity is 0.2 m/s.

Type		AW13-EC	AW23-EC	AW43-EC	AW63-EC
Voltage/Frequency		230 VAC 1-ph. 50/60 Hz	230 VAC 1-ph. 50/60 Hz	230 VAC 1-ph. 50/60 Hz	230 VAC 1-ph. 50/60 Hz
Power consumption 50/60 Hz	A	0.8	0.85	1.3	1.9
Air volume (low/medium/high speed) ³⁾	m ³ /h	500 / 900 / 1500	1100 / 1700 / 2300	1500 / 2400 / 3900	2200 / 3500 / 5200
Sound pressure level ¹⁾ (low/medium/high speed)	dB(A)	34 / 41 / 51	37 / 47 / 55	38 / 48 / 55	46 / 56 / 65
Horizontal range ²⁾ (high speed)	m	4.5	7.0	9.0	14.0
Horizontal range with AWLA ²⁾ (high speed)	m	6.5	10.0	12.5	19.0
Connector pipe	Ø mm	22	22	28	28
Max. operating temp. water, AW-a	°C	100	100	100	100
Max. operating temp. water AW-s	°C	150	150	150	150
Max. operating pressure (of water)	bar	10	10	10	10
Max. ambient temperature	°C	30	30	30	30
Can be ordered for execution -a		X	X	X	X
Can be ordered for execution -s		X	X	X	X
Weight	kg	17	23	32	46
Degree of protection		IP54	IP54	IP54	IP44

¹⁾ Measured at 5 metres in front of AW unit.

²⁾ Horizontal range shown applies for inlet air temperature of +40 °C and room temperature of +18 °C. The horizontal range is defined as the distance from the fan air heater to the point where air velocity is 0.2 m/s.

³⁾ The air flow at low, medium and high speed for EC applies to model -a. Model -s only has high speed.

AW-a

Fan heater for hot water with built-in control equipment for fan and water control

AW-a fans heaters with integrated control equipment provides for a simple installation among others due to less cabling.

This in turn reduces both the installation cost and the risk of misconnections.

AW-a fan heaters can be controlled by an sensor or external 0...10 V control signal.

The fans are available in both AC and EX execution.

Model -a

AW-a fan heaters are supplied with integrated automation for fan and water adjustment, complete with valve and actuator. For the KVS value of the valve, see table on right.

AW-a fan heaters include automatic control of fan speed in three stages depending on the heat requirement. When there is no need for heating, the fan stops and the valve shuts off the water flow, which reduces heat losses and saves both energy and money.

This also leads to a low noise level and reduces fouling of the water battery and fan.

Valve Size	KVS
AW 13a	7.3
AW 23a	7.3
AW 43a	11.8
AW 63a	11.8

Feedback Control

AW-a fan heaters are to be complemented with external room sensors and setpoint adjusters, see next page for examples. AW-a fan heaters can also be controlled by an external 0...10 V control signal.

An AW-a fan heater with a connected sensor can control an unlimited number of AW-a units as slaves as well as our type CAW-a ceiling-mounted fan heaters. The units controlled as slaves then do not need any sensor as they receive their control signal from the AW-a unit with sensor.

See next page for sensors.

Installation

AW-a fan heaters can be mounted on ceilings with bracket AWT and on walls with bracket AWW.

Supplied with a wall bracket.

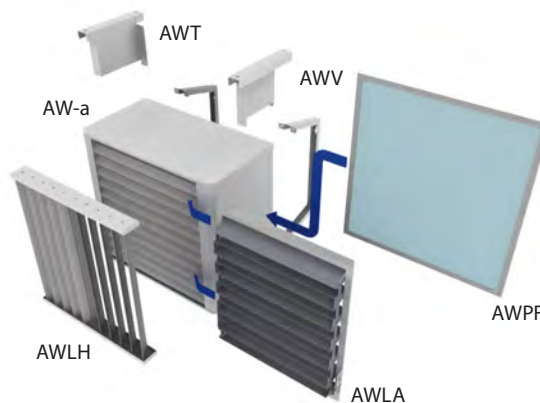







Project Design/Orders

Description – AW-a

Hot water fan heater, VEAB type AW-a, with white lacquered galvanised sheet steel casing. Coil with copper pipes and aluminium fins. Integrated control equipment that controls the fan with three speeds according to the heating requirement and also opens/closes the flow of water. Setpoint is adjusted externally with a sensor or a 0...10 V control signal. Accessories, such as sensors, setpoint adjusters, filters, air deflector AWLH and ceiling bracket are to be ordered separately.

Accessories

	Product	Range	Degree of protection
	Room sensor TG-R430 With setpoint adjustment.	Range 0-30 °C	IP30
	Room sensor TG-R530. To be complemented with TG-R430 for setpoint adjustment.	Range 0-30 °C	IP30
	Room sensor TG-R630. To be complemented with TG-R430 for setpoint adjustment.	Range 0-30 °C	IP54

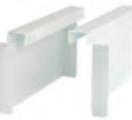
	Product	
	Filter AWP A flat filter to be fitted in the AW between fan and water coil.	Max. hot water temperature at the installed filter is 100 °C
	Air deflector AWLH Aluminium deflector blades. Direct air flow sideways. Cannot be used together with AWLA.	
	Air accelerator AWLA Extends the horizontal range by 40% on average. Cannot be used together with AWLH.	
	Ceiling bracket AWT	Distance between ceiling and AW is 150 mm.

AW-s

Fan heater for hot water for external control equipment

AW-s fans heaters for external control equipment are the right choice for those who want a simple fan heater without giving up on quality. The fans are available in both AC and EX execution.

Model -s

AW-s fan heaters are supplied without control equipment. AW-s fan heaters have three fan speeds as standard. The speed can be controlled using selector AWC or selected when carrying out the electrical installation. The EC models are supplied with just one fan speed (high speed).

Feedback Control

AW-s fan heaters are to be complemented with a room thermostat, valve with actuator and optional speed selector. See next page.

Valve	Kv
AWTV 12/22, IP44	7.3
AWTV 42/62, IP44	11.8

Installation

AW-s fan heaters can be mounted on ceilings with bracket AWT and on walls with bracket AWV. Supplied with a wall bracket.

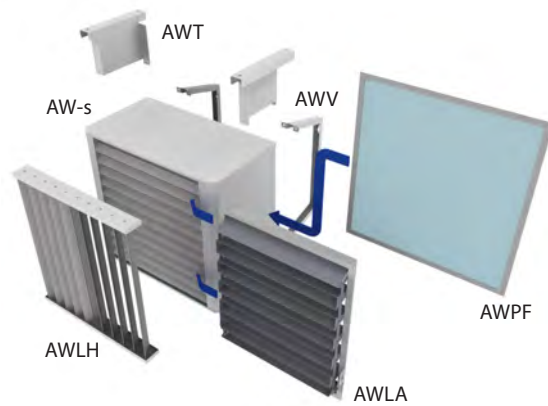

Project Design/Orders

Description – AW-s







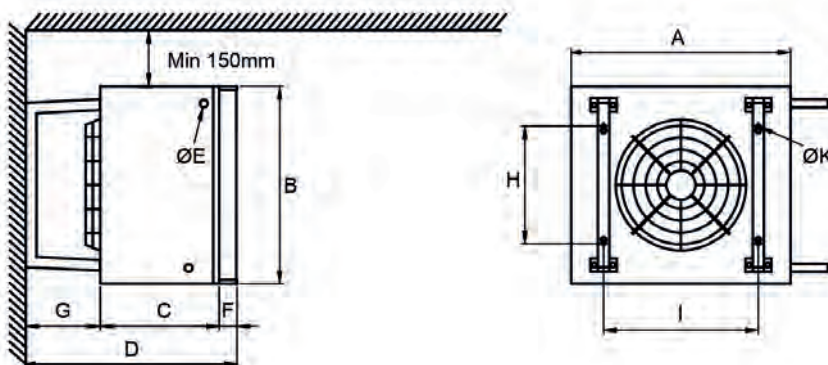

Hot water fan heater, VEAB type AW-s with white lacquered galvanised sheet steel casing. Coil with copper pipes and aluminium fins. Three-speed fan motor. Accessories, such as thermostat, filter, air deflector AWLH and ceiling bracket are to be ordered separately.



Dimension Drawing for AW-a and AW-s

Dimensions	A mm	W mm	C mm	D mm	E Ø mm	F mm	G mm	H mm	I mm	Ø K mm
AW 13	465	430	275	520	22	46	200	260	330	10
AW 23	540	530	300	550	22	46	200	340	410	10
AW 43	690	655	350	690	28	70	270	420	505	10
AW 63	835	780	395	735	28	70	270	550	640	10



Accessories

	Product	Range	Degree of protection
	Valve with actuator AWTV 13-63, IP44 To be used together with thermostat R31 or SR 121/1.	Max. 90°C 25 bar	IP44
	Speed selector AWC 13-63 Controls up to two AW-s units. Not for EC models. 1 = low speed, 2 = medium speed, 3 = high speed		IP42
	Speed selector SMT-D-4P-EM for -EC fans. Controls one AW -EC model – s 1 = low speed, 2 = medium speed, 3 = high speed		IP54
	Thermostat SR 121/1 Can control two AW-s units.	Range 0-40 °C	IP54
	Room thermostat R31 Can control one AW-s unit.	Range 7-30°C	IP20
	Valve ZTR20-6.0 three-way valve for AW 13s and AW 23s.		
	Valve ZTRB25-8 three-way valve for AW 43s and AW 63s.		
	Actuator RVAZ4-230 used for three-way valve. Connected to thermostat SR 121/1 or R31 equipped with alternating contact.		IP44

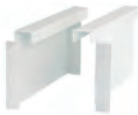
	Product	
	Filter AWPF A flat filter to be fitted in the AW between fan and water coil.	Max. hot water temperature at the installed filter is 100 °C
	Air deflector AWLH Aluminium deflector blades. Direct air flow sideways. Cannot be used together with AWLA.	
	Air accelerator AWLA Extends the horizontal range by 40% on average Cannot be used together with AWLH.	
	Ceiling bracket AWT	Distance between ceiling and AW is 150 mm.



VEAB Heat Tech AB
Tel +46(0)451-485 00
www.veab.com • veab@veab.com
Sweden



CAW
Ceiling-mounted fan heaters
for hot water

CAW

Ceiling-mounted fan heaters for hot water

CAW ceiling-mounted fans are used to heat entrances, warehouses, industrial plants, workshops, sports halls, garages and stores. The low height implies that CAW units can also be installed in false ceilings. The fans are for 230 VAC 1-ph., which makes their installation very easy. The fans have a low noise level and ensure safe operation.

The fans in CAW 21 and CAW 41 are available in both AC and EX execution.

- Three sizes and two models
- Available with integrated control equipment for sensor control or for external 0...10 V control signal
- Hinged front panel provides easy access to coil and fan for inspection and cleaning
- To be installed in ceilings—saves wall space
- Low height—can be installed in false ceilings
- Easy 230 VAC 1-ph. installation
- Two fan speeds as standard

Design

The casing is made of galvanised, white-painted steel plate. The water battery has copper pipes and aluminium fins. Ball bearing-mounted fan with thermal protection ensures low noise and safe operation. The front panel is hinged, which makes it easy to open for cleaning and inspection of battery insert and fan.

CAW fan heaters are available in two models CAW-a and CAW-s.

Dimensioning

Dimensioning can easily be achieved with our web-based calculation program VEAB Select (www.veab.com).

If necessary, contact our sales staff for help.

Installation

To be installed directly on ceiling or in ceiling suspensions.



Control Unit

Integrated Control Equipment

-a

Fan heater with integrated control equipment for external sensor and setpoint adjustment. Can also be controlled by an external 0...10 V control signal. See pages 4 and 5.

External Control Equipment

-s

Fan heater for external control equipment. Has two fan-speeds. See pages 6 and 7.

Approvals

Our fan heaters are produced in accordance with the following directives:

LVD directive: EN 60355-1 and EN 60335-2-30

EMC directives: EN 61000-6-2 and EN 61000-6-3

EMF directive: EN 62233



Product Range Overview with Dimensional Drawing

Type		CAW 11	CAW 21	CAW 41	CAW 21-EC	CAW 41-EC
Voltage/ Frequency		230 VAC 50/60Hz	230 VAC 50/60Hz	230 VAC 50/60Hz	230 VAC 50/60Hz	230 VAC 50/60Hz
Power consumption, max.	A	0.4	0.6	1.0	1.0	1.3
Air volume (low/high speed)	m ³ /h	700 / 1100	1200 / 2000	2100 / 3700	1400 / 2100	2400 / 3600
Sound pressure level ¹⁾ (low/high speed)	dB(A)	37 / 53	44 / 57	48 / 60	45 / 56	48 / 57
Vertical range ²⁾ (low/high speed)	m	2.2 / 4	2.7 / 4.5	4.5 / 7.5	2.7 / 4.5	4.5 / 7.5
Vertical range ²⁾ with CAWE (low/high speed)	m	4 / 7	5 / 8	7 / 12	5 / 8	7 / 12
Connector pipe	Ø	22	22	28	22	28
Max. operating temp. water	°C	80°C	80°C	80°C	80°C	80°C
Max. operating pressure (of water)	bar	10	10	10	10	10
Ambient temperature	°C	3-30 °C	3-30 °C	3-30 °C	3-30 °C	3-30 °C
Degree of protection		IP44	IP44	IP44	IP54	IP54
Weight	kg	19	26	41	26	41

¹⁾ Measured at 5 metres in front of fan exhaust.

²⁾ Information is based on the following: From the ceiling to the point where the air velocity is 0.2 m/s, room temperature 18 °C and outlet air temperature 40 °C.

³⁾ Model -a is supplied as standard with IP44-rated valve actuator.

Dimensions	A mm	W mm	C mm	D mm	E mm	F mm	G mm	H mm	K mm	ØL mm
CAW 11	535	640	280	670	705	125	195	330	135	305
CAW 21	675	760	420	790	825	115	195	355	160	355
CAW 41	710	1070	480	1100	1135	110	300	415	115	430

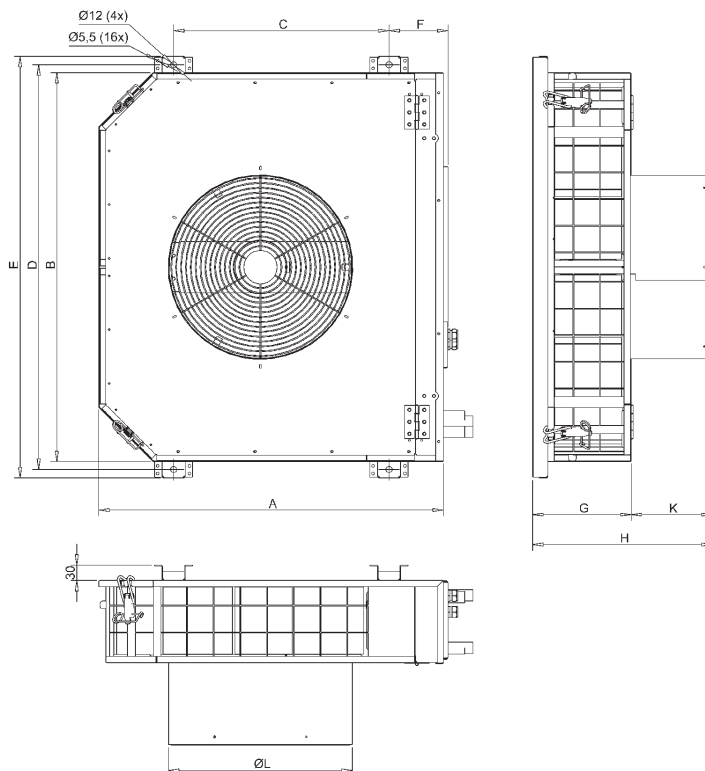

CAW-a

Fan heater for hot water with built-in control equipment for fan and water control

CAW-a fan heaters with integrated control equipment provide for a simple installation among others due to less cabling.

This in turn reduces both the installation cost and the risk of misconnections.

The control equipment is suitable for an external temperature sensor and setpoint adjuster, or an external 0...10 V control signal.

The fans in CAW 21 and CAW 41 are available in both AC and EX execution.

Model -a

CAW-a fan heaters come with integrated control equipment with an electronic thermostat that starts/stops the fan and opens/closes the flow of water.

The thermostat uses a three-stage automatic feedback control:
Stage 1 – Only fan on low speed, without hot water. This function makes use of the warm air stored under the ceiling, which ensures efficient use of energy and saves money.

Stage 2 – The fan is kept at a low speed and the hot water valve opens.

Stage 3 – The fan is kept at a high speed and the hot water valve opens.

Feedback Control

CAW-a fan heaters are to be complemented with an external room sensor and setpoint adjuster, see next page for examples. CAW-a fan heaters can also be controlled by an external 0...10 V control signal.

A CAW-a fan heater with a connected sensor can control an unlimited number of CAW-a units as slaves as well as our type AW-a wall-mounted fan heaters. The units controlled as slaves then do not need any sensor as they receive their control signal from the CAW-a unit with sensor. See next page for sensors.

Accessories

See next page for sensors that are suitable for CAW-a units.



Installation







CAW-a units are to be installed directly on the ceiling or in ceiling suspensions.

Project Design/Orders

Description – CAW-a

Ceiling-mounted hot water fan heater, VEAB type CAW-a, with white lacquered galvanised sheet steel casing. Water batteries with copper pipes and aluminium fins. Hinged front panel provides easy access to battery insert and fan for inspection and cleaning. Integrated control equipment for fan and water adjustment. Setpoint adjustment is performed externally. Accessories, such as room sensor, setpoint adjuster, filter and extension pipe are to be ordered separately.

Accessories

	Product	Range	Degree of protection
	Room sensor TG-R430 With setpoint adjustment.	Range 0-30 °C	IP30
	Room sensor TG-R530 To be complemented with TG-R430 for setpoint adjustment.	Range 0-30 °C	IP30
	Room sensor TG-R630. To be complemented with TG-R430 for setpoint adjustment.	Range 0-30 °C	IP54
	Extension pipe CAWE The extension is used for taller ceiling heights to increase the range of the blown air. Length: 350 mm.		
	Filter CAWF Filter to be mounted in CAW.		
	Air deflector CAWL Aluminium deflector blades. Direct air flow sideways.		

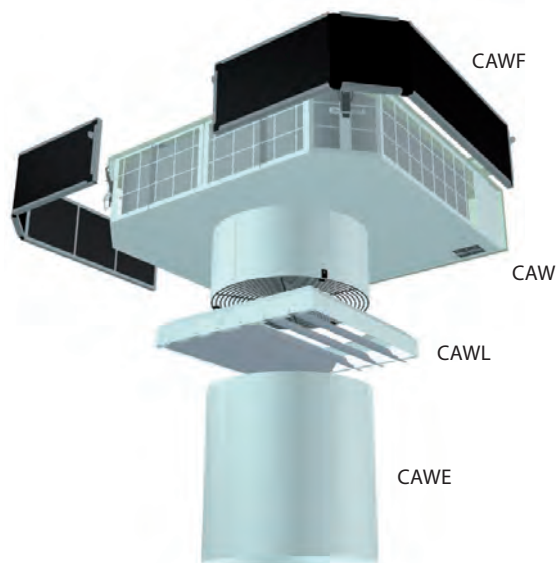

CAW-s

Fan heater for hot water for external control equipment

CAW-s fan heaters for external control equipment are the right choice for those who want a simple fan heater without giving up on quality.

The fans in CAW 21 and CAW 41 are available in both AC and EX execution.

Model -s

CAW-s for external control device has two fan speeds. The speed is selected at electrical installation or via an external CAWC selector.

CAW-s fan heaters with EC motor has a single fan speed and requires an SMT-D-4P-EM external speed selector if you want to adjust the fan speed.

Feedback Control

CAW-s are complemented with an external room thermostat, speed selector, as well as an actuator and valve. See next page for examples.

Accessories

See next page for accessories that are suitable for CAW-s units.

Installation

CAW-s units are to be installed directly on the ceiling or in ceiling suspensions.



Project Design/Orders

Description – CAW-s

Ceiling-mounted hot water fan heater, VEAB type CAW-s, with white lacquered galvanised sheet steel casing. Water batteries with copper pipes and aluminium fins. Fan motor with two speeds. Hinged front panel provides easy access to battery insert and fan for inspection and cleaning. Accessories, such as thermostat, speed selector, actuator and valve, as well as extension pipe, are to be ordered separately.

Accessories

	Product	Range	Degree of protection
	Actuator and valve AWTV, IP44 Used together with thermostat R31 or SR 121/1.	90 °C, 25 bar max. CAW 11-21: 7.3 Kv CAW 41: 11.8 Kv	IP44
	Speed selector CAWC 11-41 Can control up to four CAW-s units. 0 = off 1 = low speed 2 = high speed Not for EC models		IP42
	Speed selector SMT-D-4P-EM for -EC fans. Controls one CAW -EC model – s 1 = low speed, 2 = medium speed, 3 = high speed		IP54
	Thermostat SR121/1 Can control four CAW-s units.	Range 0-40 °C	IP54
	Room thermostat R31. Can control one CAW-s unit. Max; load 16 A (2.5 A) 250 VAC 1-ph.	Range 7-30°C	IP20
	Extension pipe CAWE The extension is used for taller ceiling heights to increase the range of the blown air. Length: 350 mm.		
	Filter CAWF Filter to be mounted in CAW.		
	Air deflector CAWL Aluminium deflector blades. Direct air flow sideways.		



VEAB Heat Tech AB
Tel +46(0)451-485 00
www.veab.com • veab@veab.com
Sweden



LAF
Dehumidifiers

LAF 51

Condensing dehumidifiers for professional use

VEAB condensation dehumidifiers are designed for professional use in applications with high requirements in terms of capacity. LAF dehumidifiers are therefore suitable in buildings under construction and after water damage to obtain a sufficiently low humidity in building materials, carpets and wall coverings. In cellars and warehouses, LAF dehumidifiers will keep the right humidity level to prevent issues with corrosion, odours and mould. Drying with LAF dehumidifiers is very economical and efficient. Energy consumption is minimal as compared with heating and subsequent ventilation of humidity. 700 Wh of heating energy is gained for each litre of water that is dehumidified.

- On-demand defrosting
- Operating temperature 3-30 °C
- Operating humidity range 40-100% RH
- Shuts off automatically when the container is full
- Easy to handle—large wheels make it easy to move (Ø 250 mm)
- Robust durable design suitable for construction sites
 - can be lifted with handle
- LAF 51S/51E2S is stackable

Design

Casing made of lacquered galvanised sheet metal.

Built-in collection container with a level sensor and option to attach a drain hose (Ø 13 mm).

Electronic on-demand defrosting ensures quick and efficient defrosting.

LAF 51 dehumidifiers are stackable two high to save space when storing.

IPX4 degree of protection (splash-proof design).

Electrical Heating, Addition -E2S

LAF 51E2S comes with an integrated 1500 W electrical heating element.

The model includes switches to run the dehumidifier with or without electrical heating.

A permanently set room thermostat regulates the electrical heating to 20 °C.

Connection

LAF 51 comes with a two-metre 230 V connection cable and has an earthed plug.



LAF 51

Approvals

Our dehumidifiers are manufactured in accordance with the following directives:

LVD directive: EN 60335-1 and EN 60335-2-40

EMC directives: EN 61000-6-1 and EN 61000-6-3

EMF directive: EN 62233



Product Range Overview

Type		LAF 51S	LAF 51E2S
Operating range 40-100	% RH	40-100	40-100
Operating range	°C	+3 - +30	+3 - +30
Voltage	V	230 VAC 1-ph.	230 VAC 1-ph.
Fuse	A	10	10
Power consumption, max.	W	490	2000
Power cons. at 20 °C, 60% RH	W	385	385*
Radiated heat at 20 °C, 60% RH	W	1170	2670 ³
Dehumidification at 20 °C, 60% RH	l/day	13.5	13.5
Dehumidification at 30°C, 80% RH	l/day	29.7	29.7
Power cons. at 20 °C, 60% RH	kW/l	0.69	0.69 ¹
Coolant		R 290	R 290
Minimum floor area	m ²	9	9
Air volume	m ³ /h	390	390
Sound pressure level ²	dB(A)	54	54
Volume of collection container	l	9	9
Degree of protection		IPX4	IPX4
Weight	kg	35	35.5
Depth	mm	440	440
Width	mm	540	540
Height	mm	980	980

¹⁾ Power consumption excludes possible additional heating.

²⁾ Measured at 3 metres from dehumidifier.

³⁾ Includes heating elements.

How the Dehumidifier Works

The built-in fan continuously circulates the ambient air through the dehumidifier. As the humid air flows through the evaporator (cooling battery), it is cooled down to the dew point and condensation water is precipitated. The water runs down into the container.

The integrated level sensor stops the dehumidifier when the water container is full.

The dry and cold air then continues on through the condenser where it is heated, partly by the compressor heat and partly by the energy recovered during the earlier conversion of vapour to water.

The dry and warm air is again blown out into the room to absorb more humidity.

Under certain temperature/humidity conditions, frost builds up on the cooling coil. The automatic defroster is then switched on once per hour and directs the warm gas to the cooling coil so that the frost thaws and runs down into the collection container (hot gas defrosting).

In order to accelerate dessication, the LAF 51E2S has an integrated electrical heating that increases the temperature in the room and thus leads to faster dessication.

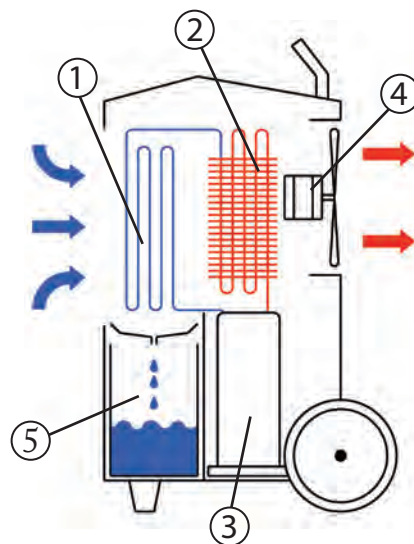

1. Evaporator
2. Condenser
3. Compressor

4. Fan
5. Collection container

Capacity

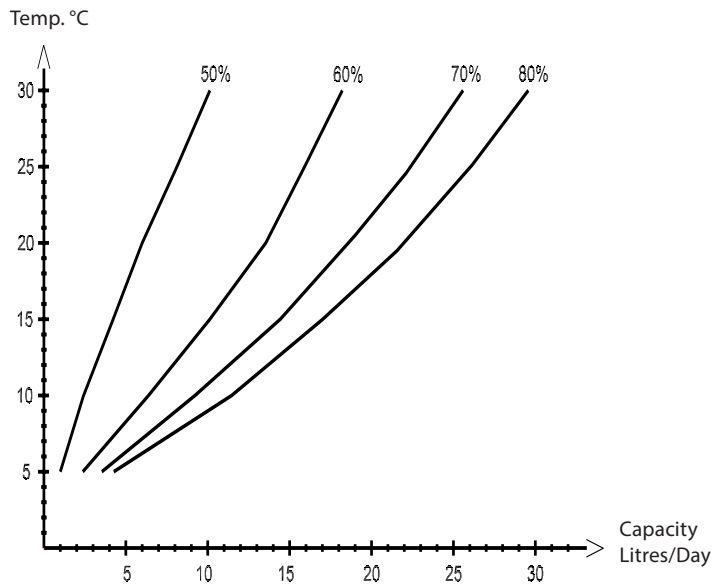

Capacity LAF 51



Dehumidification Tips

- Place the dehumidifier in such a way that it generates the best possible air circulation in the room.
- Keep doors and windows shut.
- Higher ambient temperatures accelerate dehumidification.
- At humidity levels below 50%, untreated iron will not rust.
- At humidity levels below 65%, there is no significant mould growth on wood surfaces.

Accessories

	Product
	<p>Hygrostat LAF-HY A hygrostat is available as an accessory to control the humidity in the room. The hygrostat is connected to the dehumidifier by means of a plug that is directly inserted to dehumidifier's normal cable connection. Includes mounted cables. IP21 degree of protection. (Not for use on construction sites.)</p>
	<p>Operating time counter LAF-OHM The operating time counter measures the compressor's operating time. Can supplied factory installed on the dehumidifier or as an accessory for subsequent installation.</p>
	<p>Wall bracket LAF-W For permanent installation of the dehumidifier.</p>

LAF 31

Condensing dehumidifiers for basements, water damages etc.

Owing to its low weight (18.5 kg) the LAF 31 is particularly suitable for application areas with high requirements in terms of easy dehumidifier handling. LAF dehumidifiers are suitable in the event of water damage to achieve a sufficiently low humidity level in the building's materials. In cellars and warehouses, LAF dehumidifiers will keep the right humidity level to prevent issues with corrosion, odours and mould. Drying with LAF dehumidifiers is very economical and efficient.

Energy consumption is minimal as compared with heating and subsequent ventilation of humidity. 700 Wh of heating energy is gained for each litre of water that is dehumidified.

- Low-energy rotary compressor, saves about 30% energy as compared with a piston compressor
- Operating temperature 8-32°C
- Operating humidity range 30-100% RH
- Built-in hygrostat and operating time counter
- Shuts off automatically when the container is full
- Allows for hose attachment
- Easy to handle—handle and low weight (18.5 kg)
- Durable design suitable for construction sites
- LAF 31 dehumidifiers are stackable

Design

Casing made of lacquered galvanised sheet metal. Built-in collection container with a level sensor and option to attach a drain hose (Ø 13 mm). LAF 31 dehumidifiers are stackable two high to save space when storing. IPX4 degree of protection (splash-proof design).

Connection

LAF 31 comes with a two-metre 230 V connection cable and has an earthed plug.

Control Panel

The control panel includes the following:

- Setting for desired relative humidity (hygrostat)
- Timer used to limit operating time.
- Fan speed setting (low/high).
- Display of relative humidity (hygrometer).
- Indicator light for full water container.

Operating Time Counter

Shows/calculates total operating time for compressor.



Control Panel

Approvals

Our dehumidifiers have been tested and approved by Intertek in accordance with the following directives:

LVD directive: EN 60335-1 and EN 60335-2-40

EMC directives: EN55014-1, EN55014-2, EN61000-3-2 and EN61000-3-3

EMF directive: EN 62233



Technical Data

Type		LAF 31
Operating range	% RH	30-100
Operating range	°C	+8 - +32
Voltage	V	220-240 V, 50 Hz
Fuse	A	10
Power consumption, max.	W	660
Power cons. at 20 °C, 60% RH	W	500
Dehumidification at 20 °C, 60% RH	l/day	13
Dehumidification at 30°C, 80% RH	l/day	30
Coolant		R290
Rotary compressor		Yes
Air volume (low/high speed)	m³/h	200 / 280
Sound pressure level ¹ (low/high speed)	dB(A)	47 / 51
Volume of collection container	l	6.2
Degree of protection		IPX4
Weight	kg	18.5
Depth	mm	337
Width	mm	327
Height	mm	528

¹⁾ Measured at 3 metres from dehumidifier.



Control panel and operating time counter



Capacity LAF 31

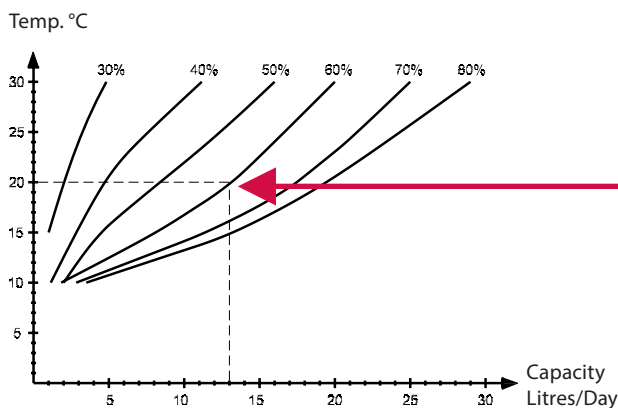

When choosing a dehumidifier it is important to compare the capacity at a normal operating point.

A usual operating point for dehumidification is 20 °C and 60% RH. (The capacity for 30 °C and 80% RH is not interesting under normal use.)

LAF 13

Compact dehumidifier for smaller premises

LAF 13 dehumidifiers reduce the atmospheric humidity and thus create a healthy and comfortable indoor climate. These dehumidifiers are suitable for use in cellars, bathrooms, laundry rooms, storage areas, living areas, and more.

- Adjustable digital hygrostat
- Display that shows current humidity
- Two fan speeds
- Low noise level
- Built-in filter
- Automatic defrosting
- Outlet for drain hose
- Low weight
- IPX2 degree of protection

Design

in collection container with a level sensor and option to attach a drain hose (hose dimension \varnothing 12 mm).

Desired humidity is easily set on the control panel.

Dehumidifier starts/tops automatically at set value.

IPX2 Degree of Protection

LAF 13 dehumidifiers are manufactured to an IPX2 degree of protection.

This degree of protection means that the dehumidifier is approved for use in humid areas, such as bathrooms and laundry rooms as well as laundry drying rooms.

Connection

The LAF13 has a two-metre 230 V connection cable and an earthed plug.

Control Panel

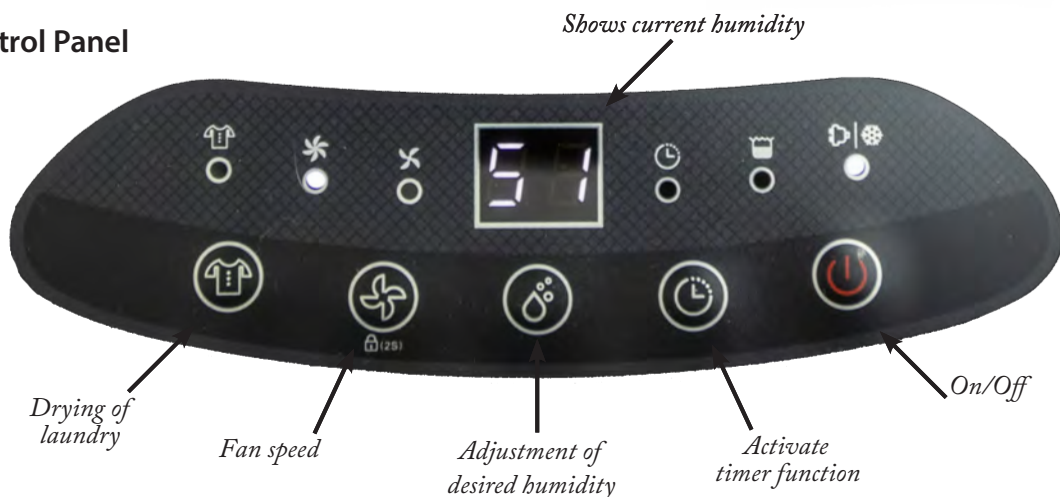

Approvals

The dehumidifiers are tested and approved by TÜV according to:

LVD directive: EN 60335-1 and EN 60335-2-40

EMC directives: EN55014-1, EN55014-2, EN61000-3-2 and EN61000-3-3

EMF directive: EN 62233



Technical Data

Type	LAF 13	
Operating range	% RH	35-80
Operating range	°C	+8 - +35
Power cons. at 20 °C / max.	W	155
Current at 20 °C / max.	A	0.9
Voltage	V	230 VAC 1-ph.
Air volume High/Low	m³/h	105 / 80
Dehumidification at 30°C, 80% RH	l/day	12.0
Dehumidification at 27 °C 60% RH	l/day	7.5
Dehumidification at 20°C 60% RH	l/day	4.2
Dehumidification at 8°C 60% RH	l/day	1.9
Degree of protection		IPX2
Coolant		R290
Water container volume	l	2.6
Sound pressure level ¹ High/L°w	dB(A)	42 / 33
Weight	kg	11.6
Width	mm	300
Depth	mm	250
Height	mm	463

¹⁾ Measured at 3 metres from dehumidifier.

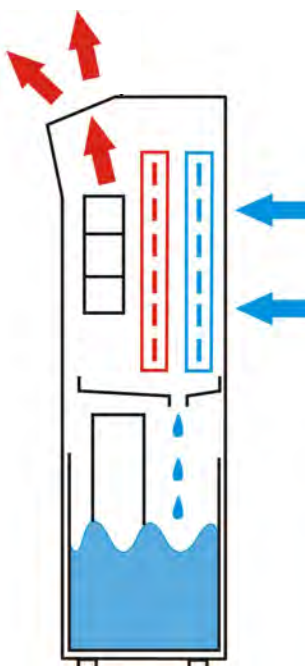

How the Dehumidifier Works

The LAF 13 works according to the same principle as a heat pump or refrigerator. The humid ambient air is cooled down as it flows through the cold evaporator. As it is cooled down, the water vapour in the air is condensed to droplets of water. Condensation water is collected in the built-in water container when automatic defrosting is on.

This process of water giving off its heat content to the air together with the compressor's heat leads the air that is blown back into the room both to be dehumidified and to keep a temperature that is approx. 5-7 °C warmer. You therefore get back in the form of warm air the electrical energy that the dehumidifier uses and the energy that is released when the water condenses.



VEAB Heat Tech AB
Phone: +46(0)451-485 00
www.veab.com • veab@veab.com
Sweden